

DOMO 65RT

SISTEMA PRACTICABLE
ROTURA DE PUENTE TÉRMICO



CARACTERÍSTICAS

- Rotura puente térmico.
- Practicable cámara europea.
- Perfiles en extrusión de aleación 6063.
- Espesor general 1.5 mm.
- Acristalamiento por medio de junquillos a presión o con grapa.
- Juntas de estanqueidad en EPDM con ángulos vulcanizados para junta central.
- Escuadras y juntas de batiente comunes para todos los sistemas practicables.
- Escuadras de unión de aluminio inyectado con pulsante de anclaje.
- Escuadras de alineamiento en acero Inox y Zamak.
- Drenaje de hoja invisible.
- Profundidad del marco 67 / 73 mm.
- Profundidad de hoja 74 mm.
- Posibilidad de combinar marcos, hojas y junquillos rectos y curvos.
- Conexión sólida mecánica de poliamida de alta resistencia.

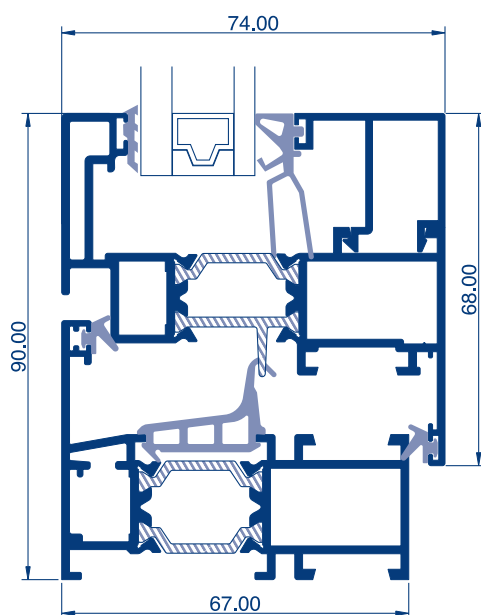

INDALSU 2011

EN 14351-1
LGAI Technological Center, S.A.
(APPLUS) Organismo Notificado N°0370

Sistema DOMO 65RT, ventana oscilobatiente
de dos hojas y medidas $\leq 2,7\text{m}^2$
Acristalamiento 6/12/4 B.E.

Resistencia a la carga de viento	Clase C5
Permeabilidad al aire	Clase 4
Estanqueidad al agua	E1650
Sustancias peligrosas	NPD
Capacidad de soporte de carga de los dispositivos de seguridad	APTO
Prestaciones acústicas	34 (-1,-4)
Transmitancia térmica (U_w)	2,7 W/m ² K

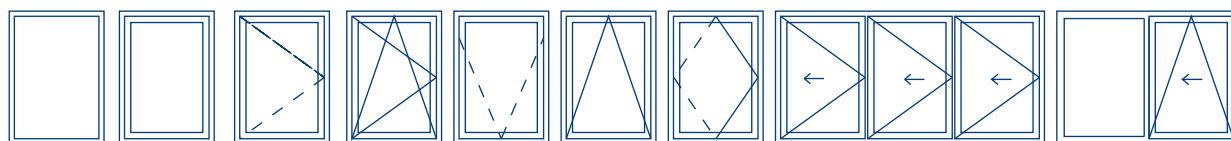

Fijo

Abatible
apertura interior

Abatible
apertura exterior

Oscilo-batiente

Proyectante
deslizante

Oscilante

Pivotante

Plegable

Oscilo-Paralela

PRACTICABLE DOMO 67RT

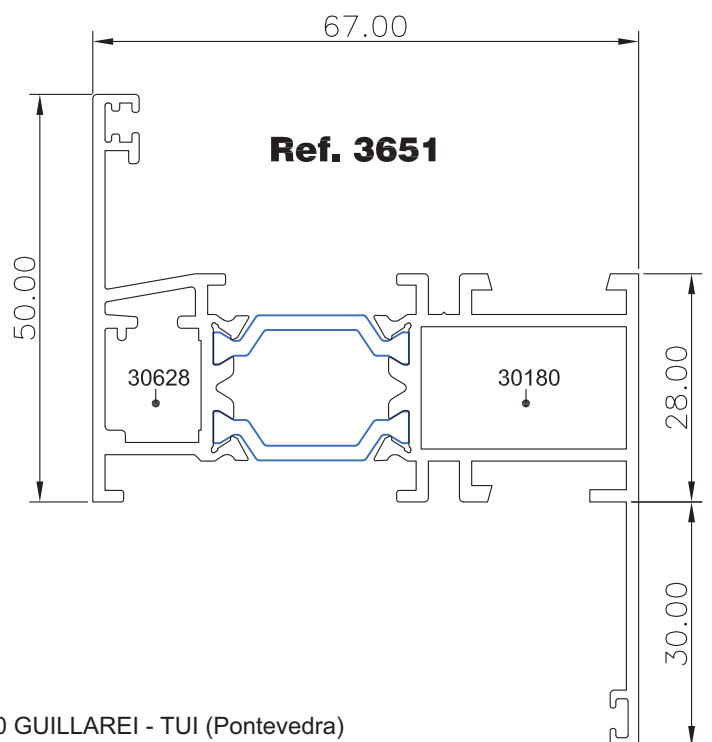
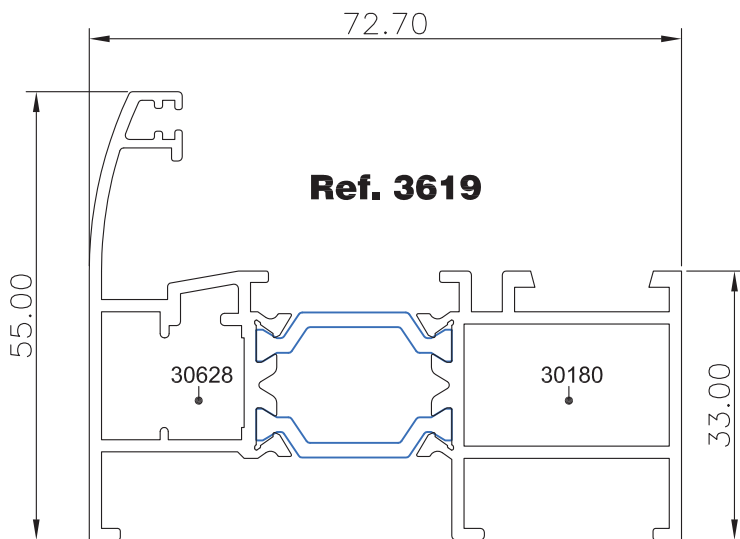
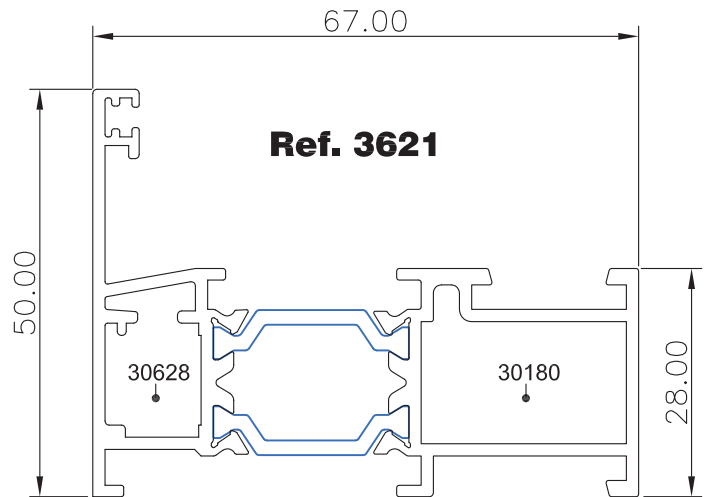
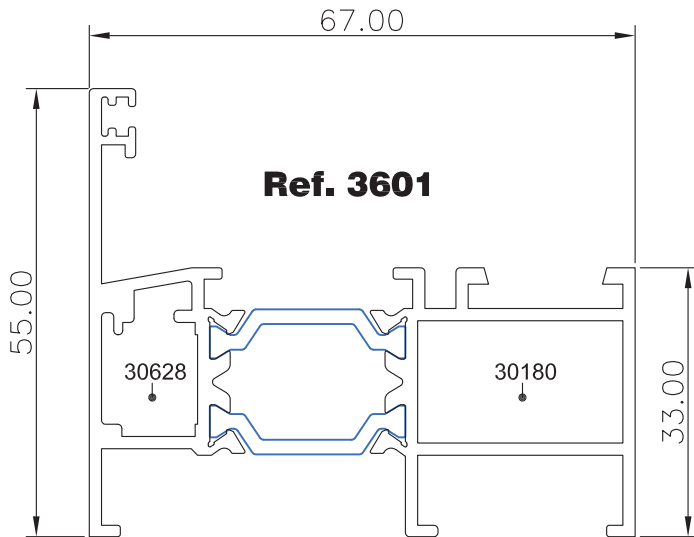

PRACTICABLE DOMO 67RT

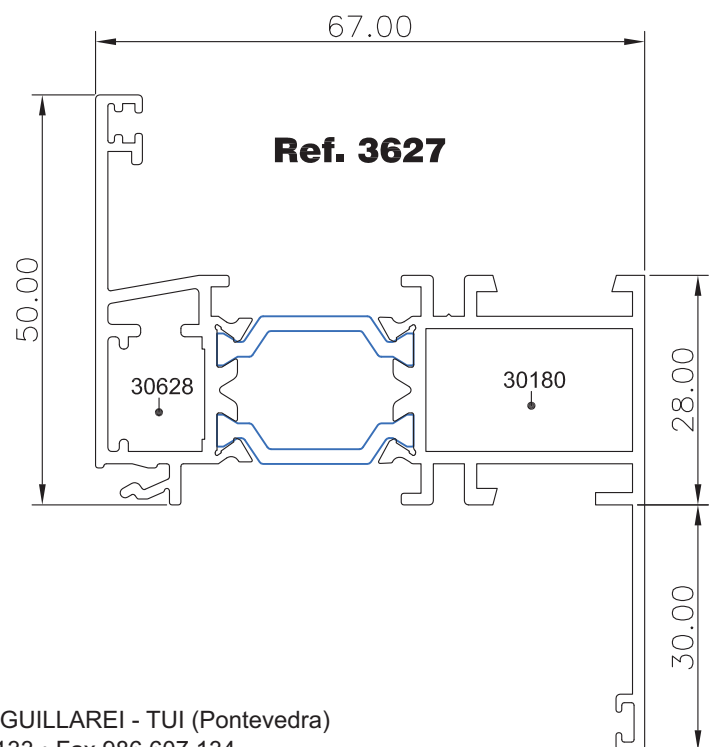
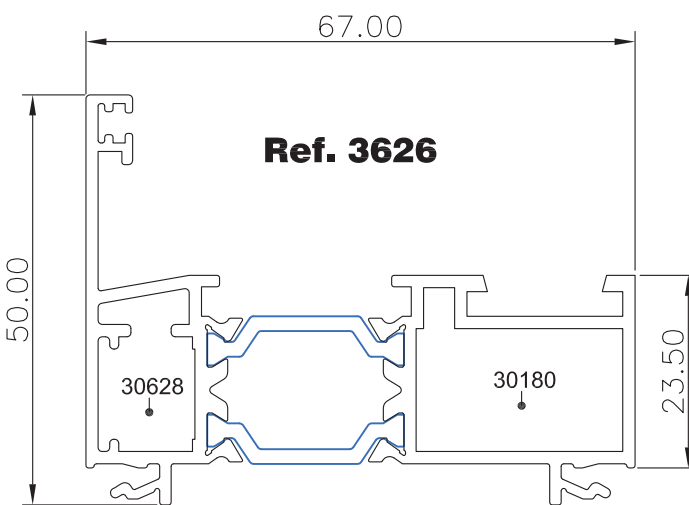
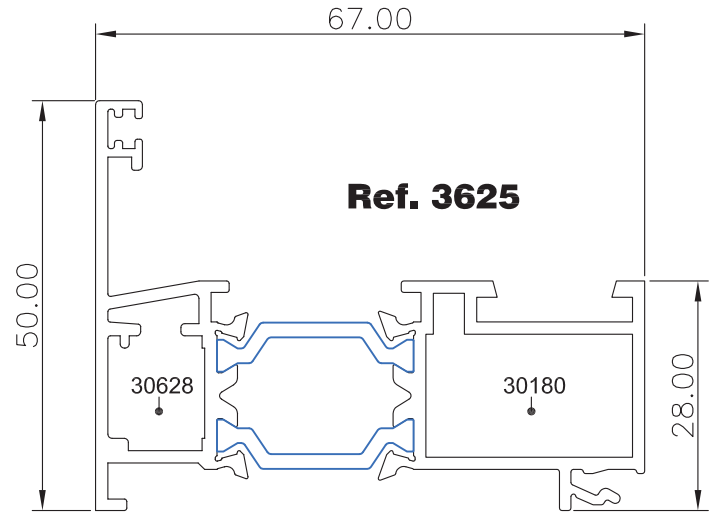
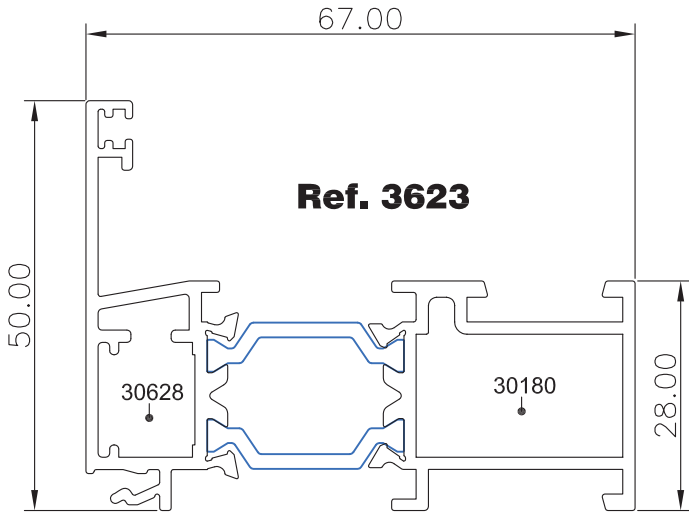

PRACTICABLE DOMO 67RT

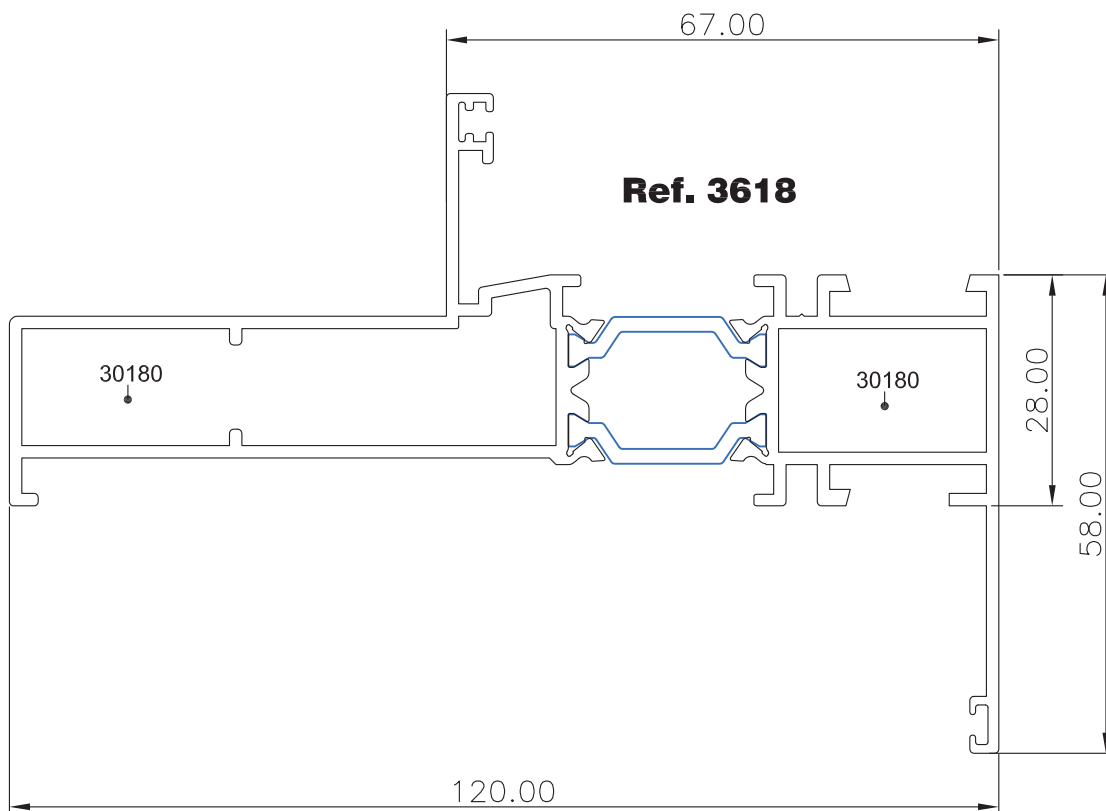
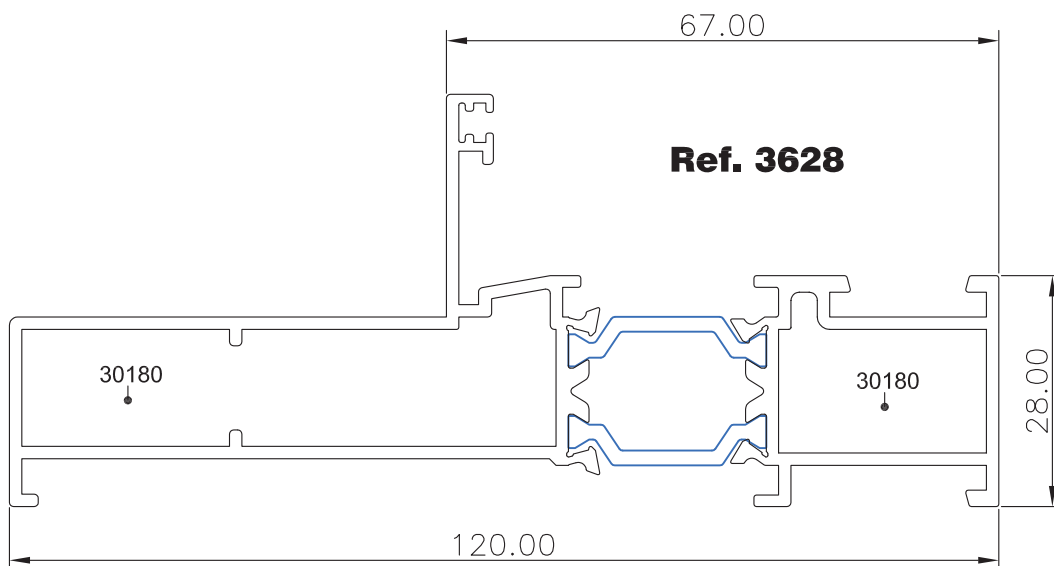

PRACTICABLE DOMO 67RT

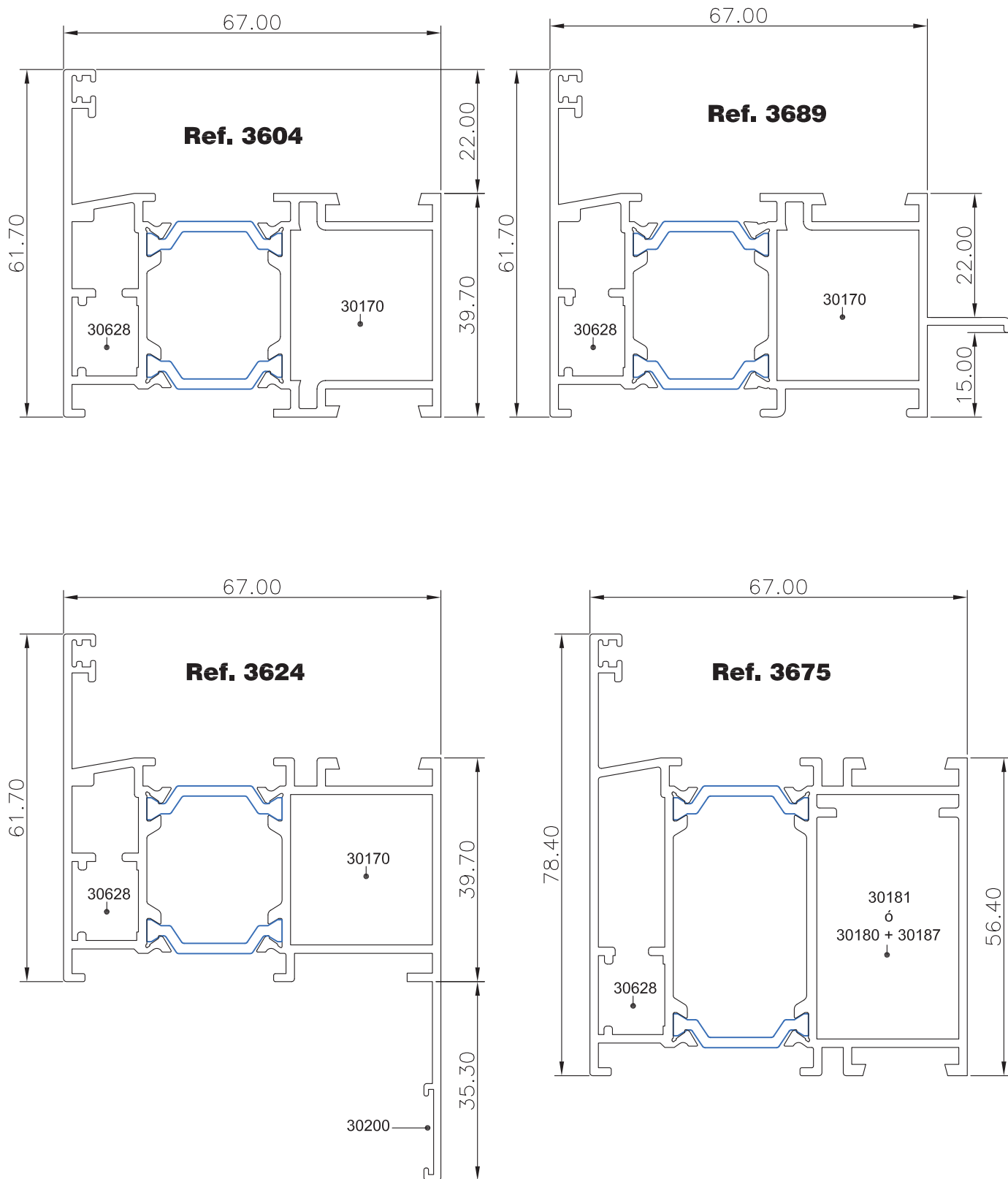

PRACTICABLE DOMO 67RT

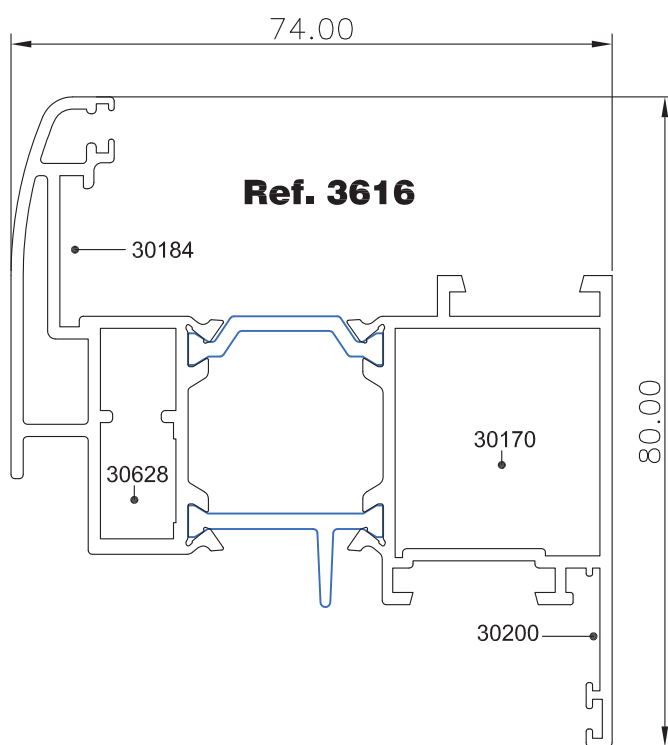
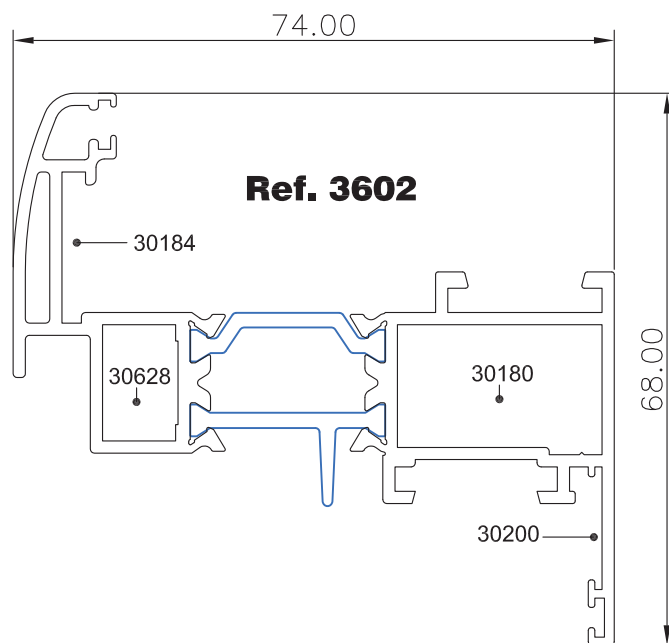
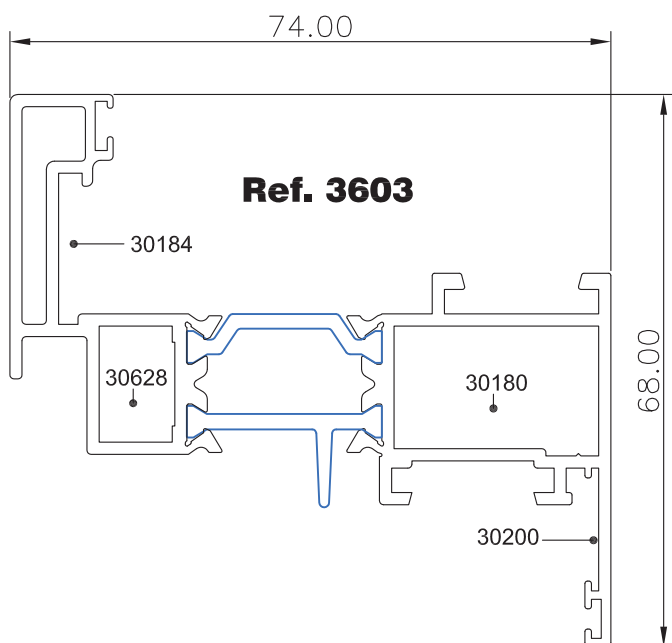

PRACTICABLE DOMO 67RT

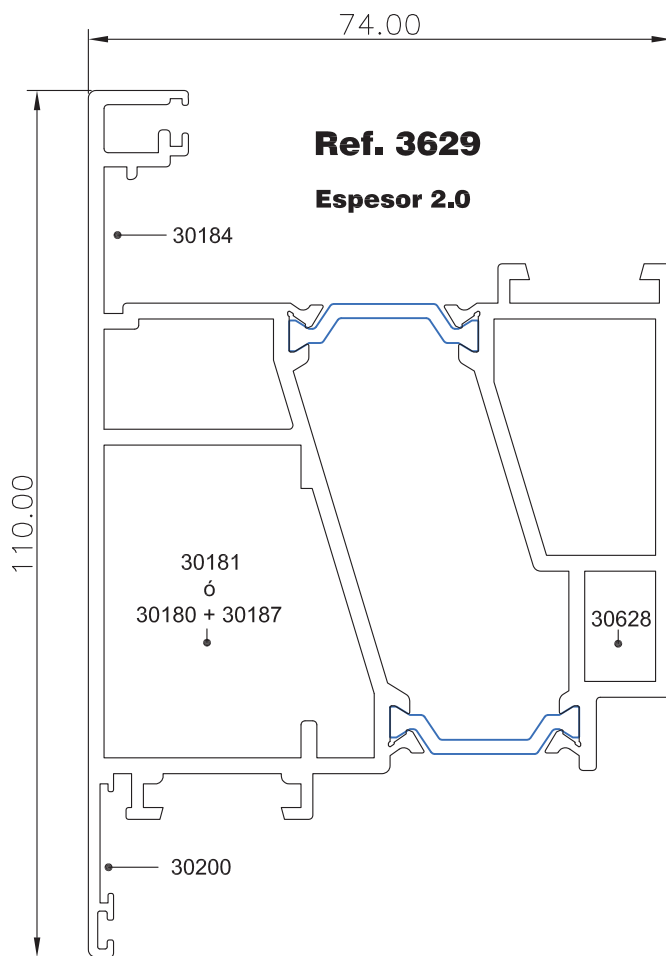
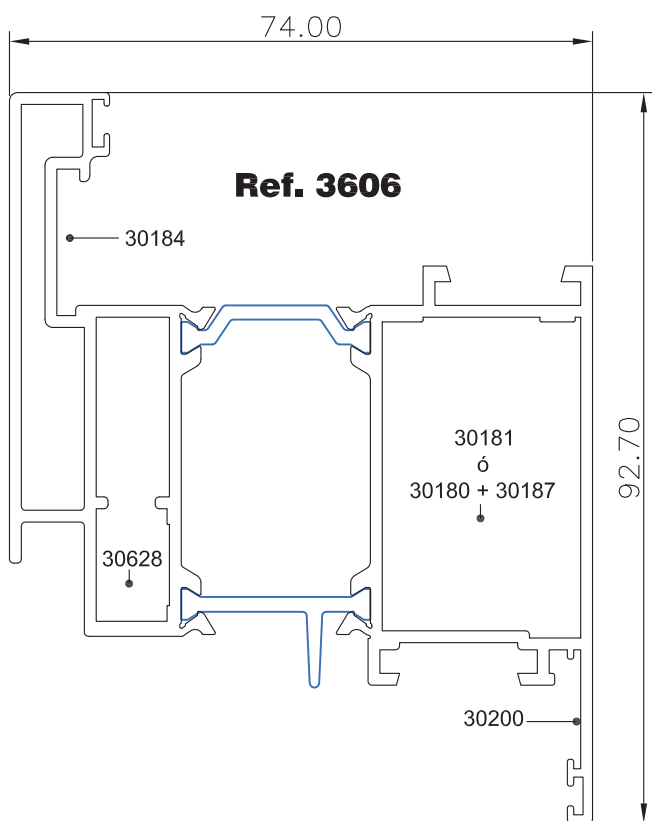
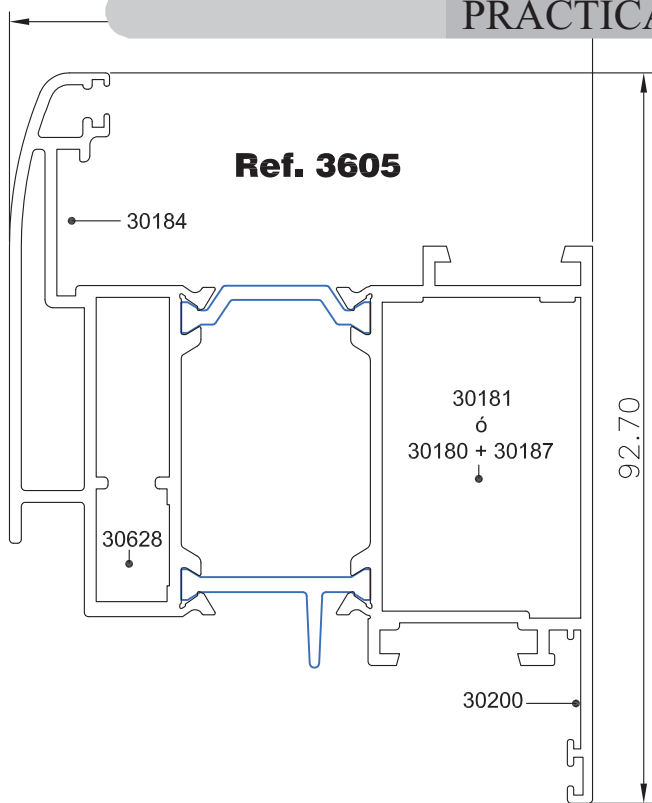

PRACTICABLE DOMO 67RT

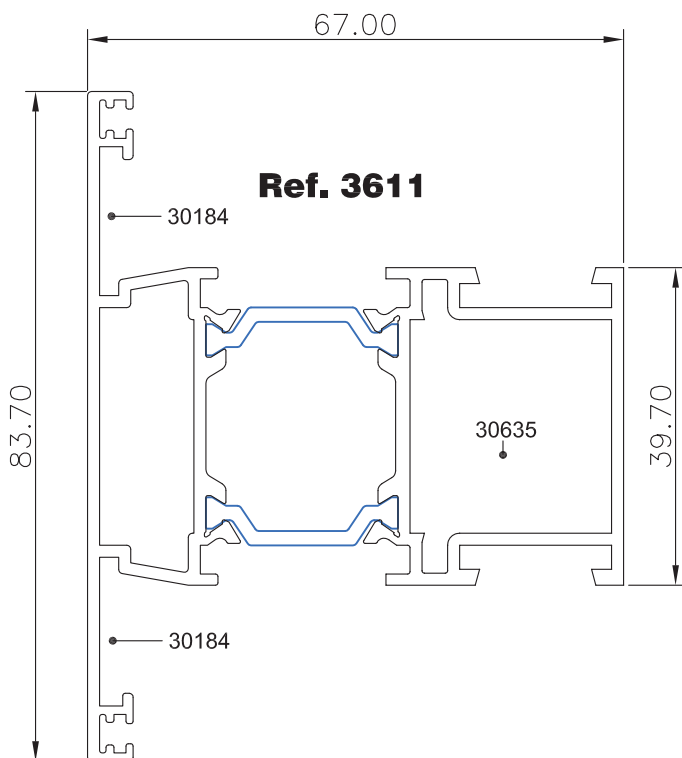
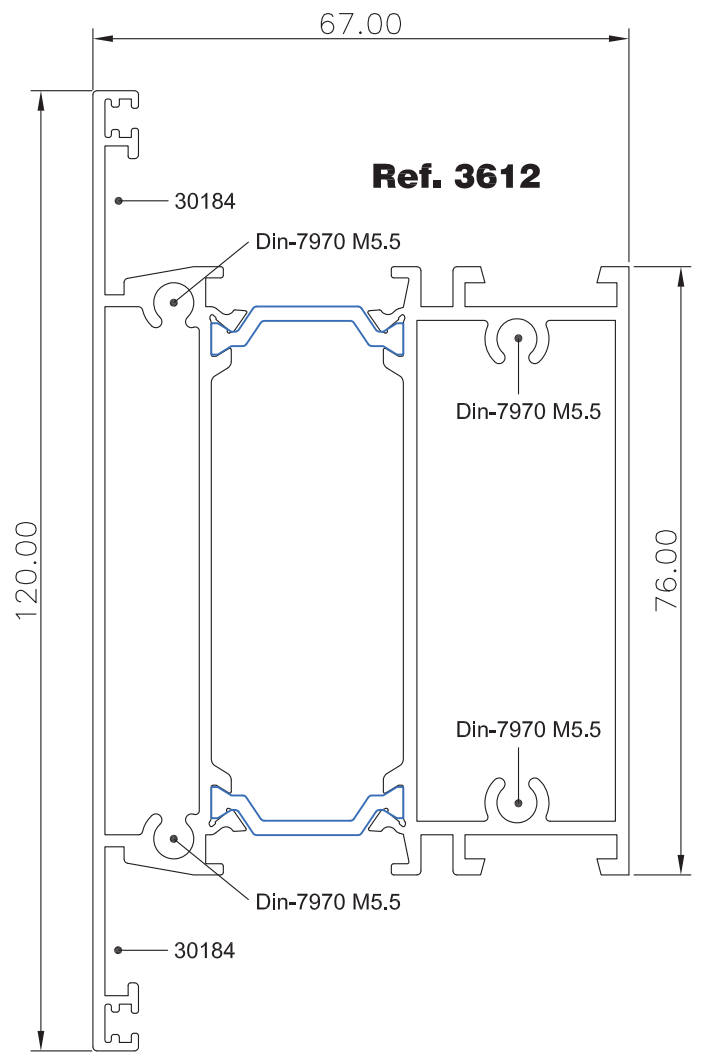
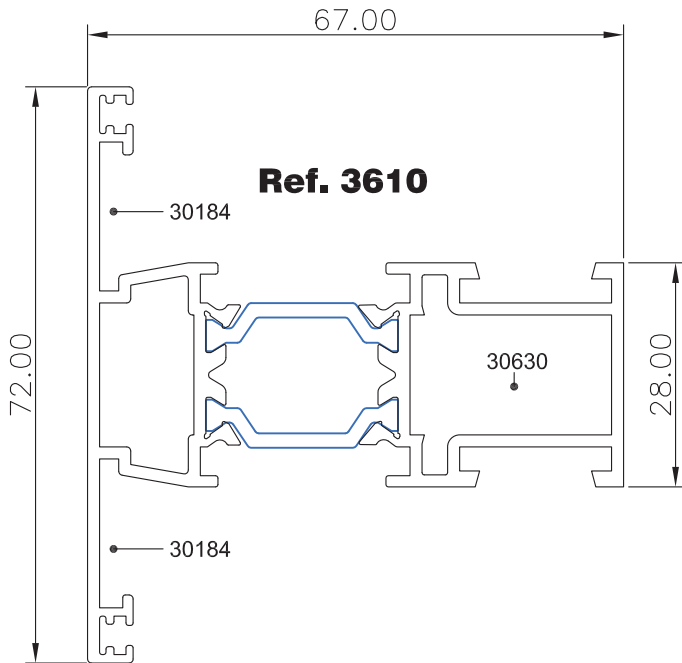



PRACTICABLE DOMO 67RT

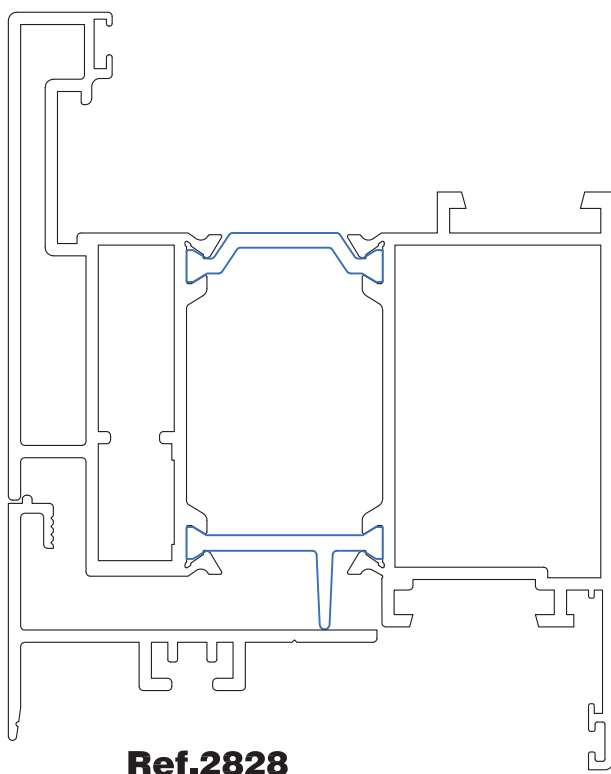
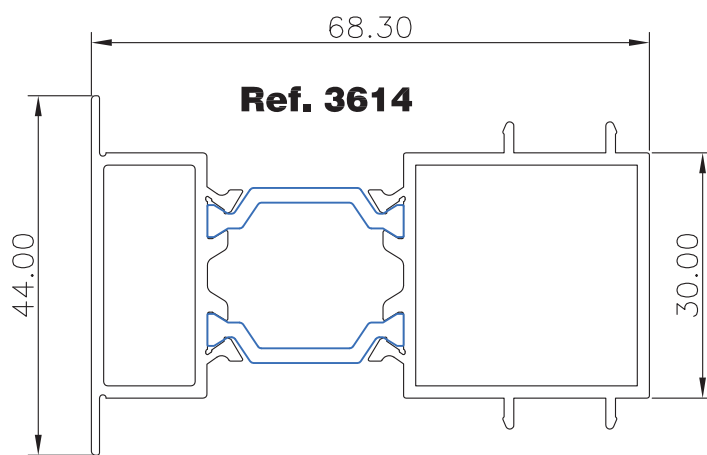
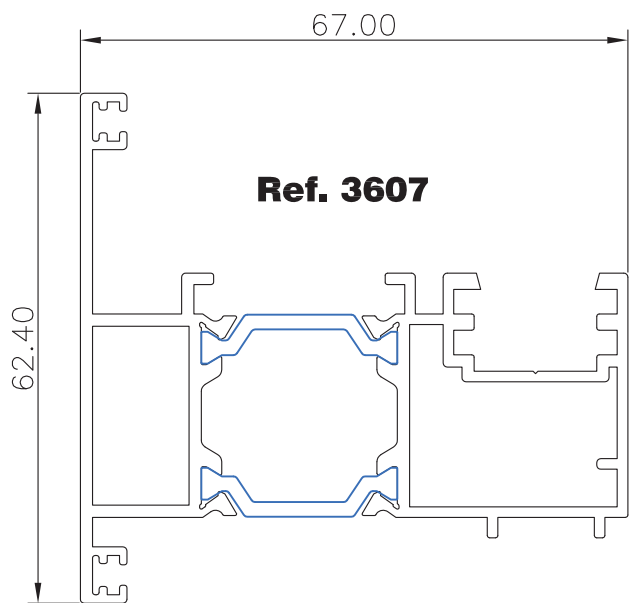

Ref. 2814



Ref.2829

PRACTICABLE DOMO 67RT

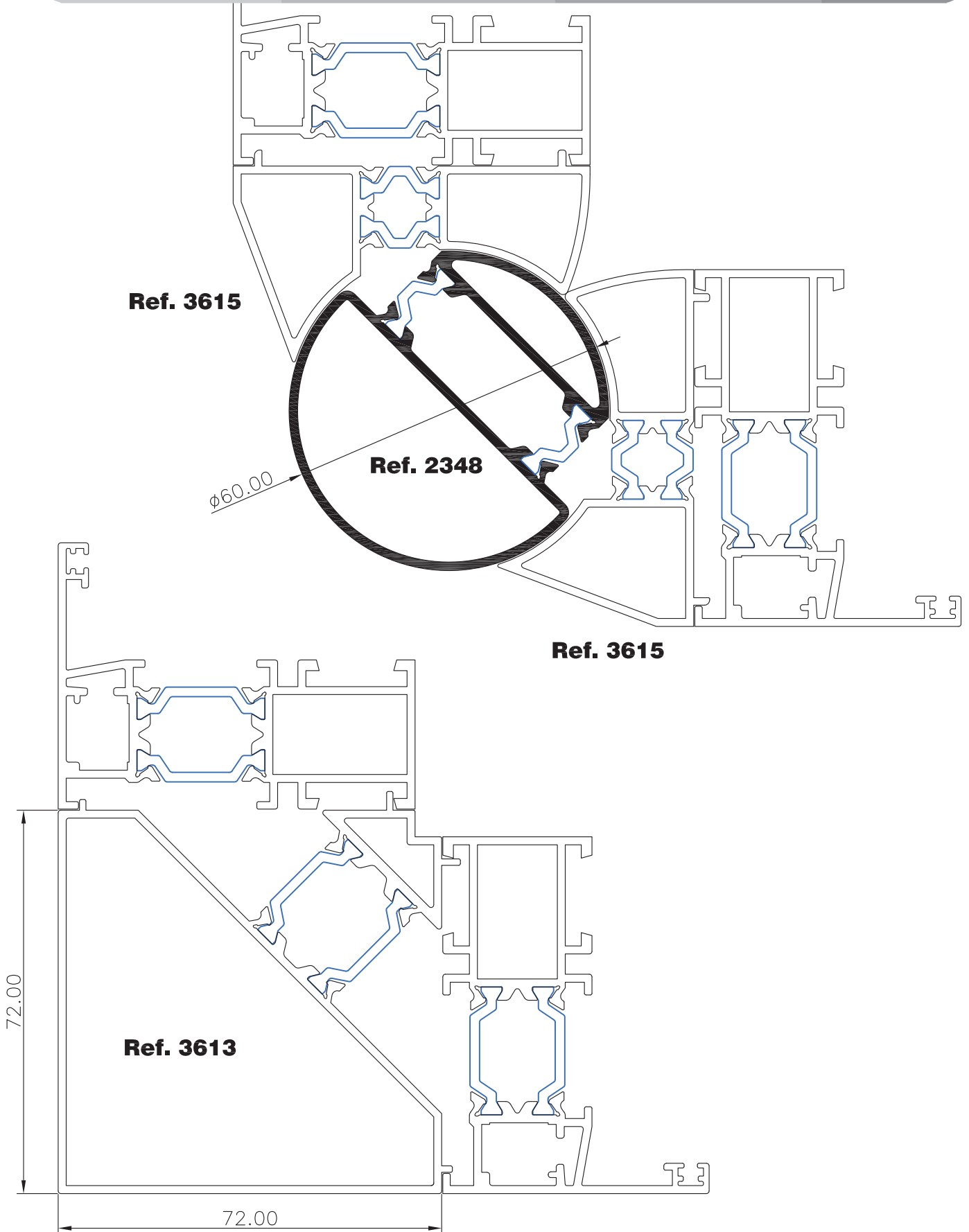

PRACTICABLE DOMO 67RT

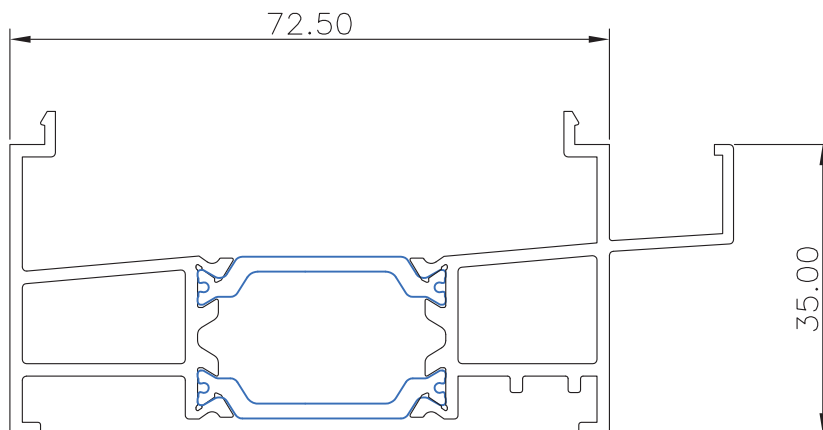

Ref. 3694

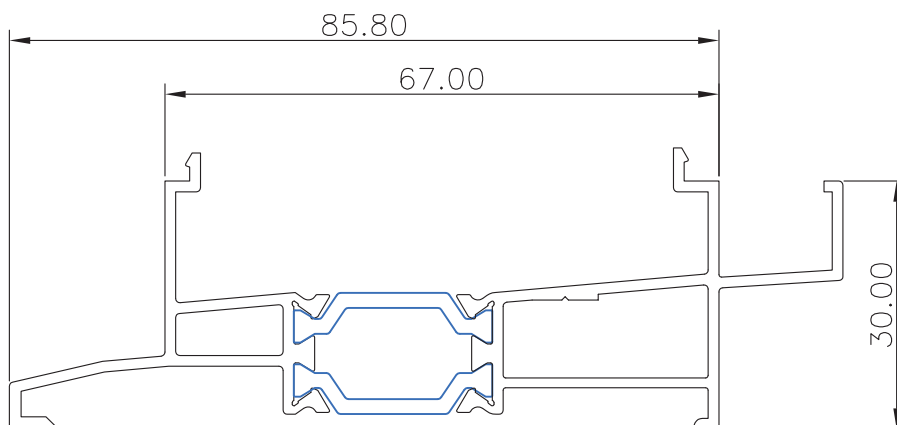

Ref. 3693

PRACTICABLE DOMO 67RT

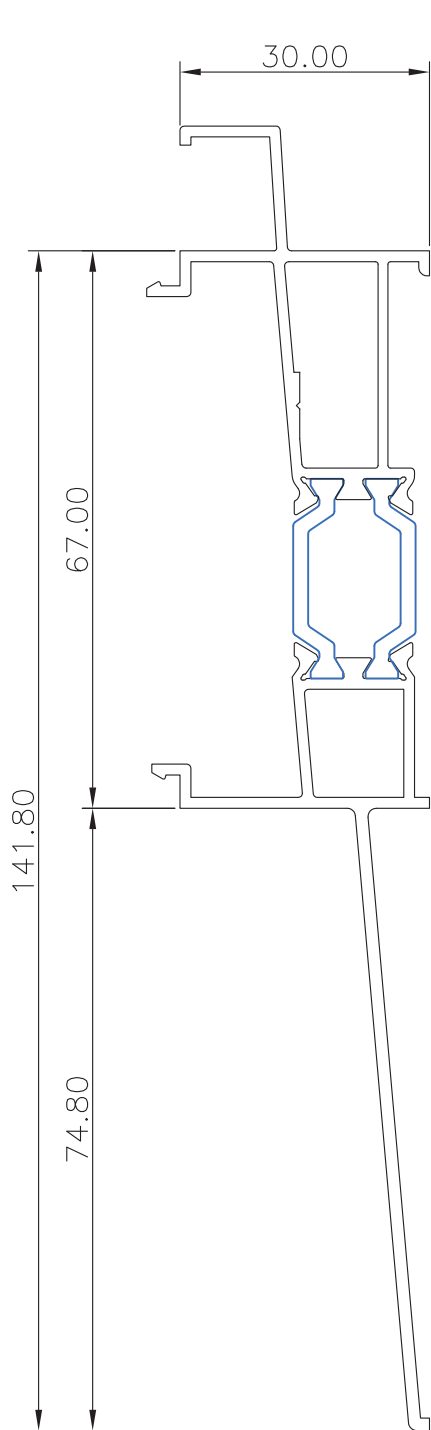

Ref. 3695

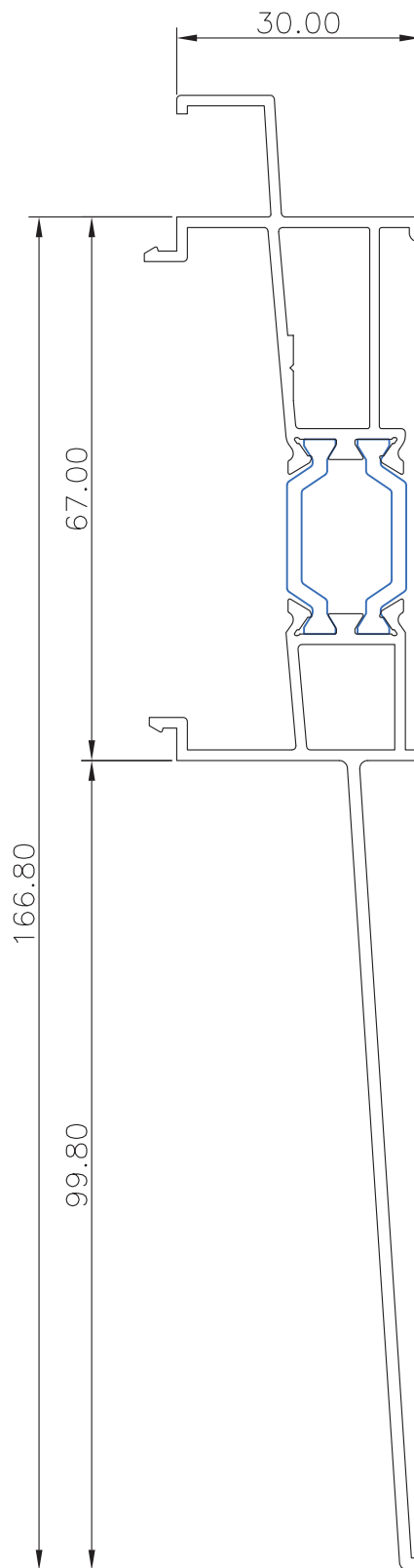

Ref. 3697

PRACTICABLE DOMO 67RT

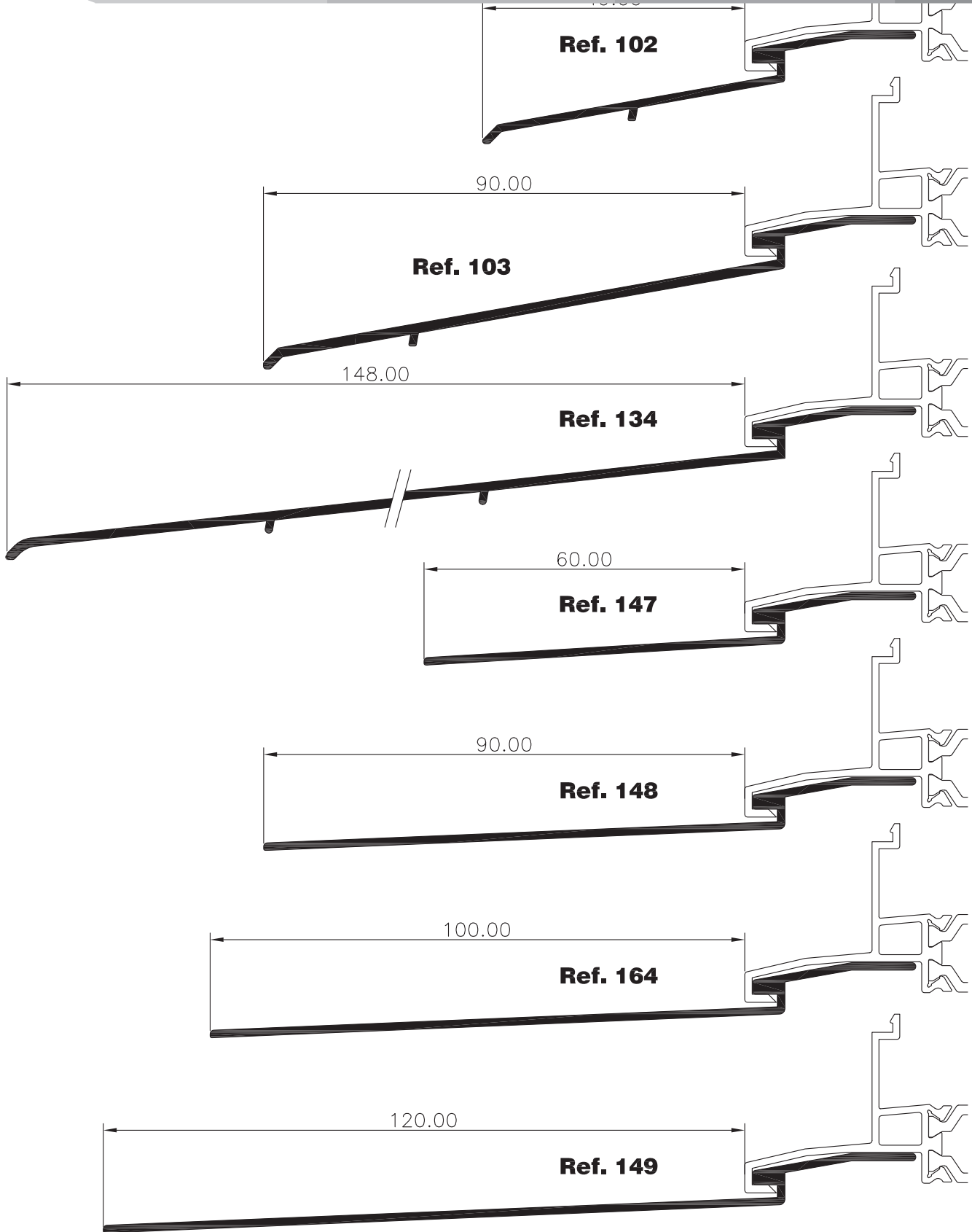



PRACTICABLE DOMO 67RT

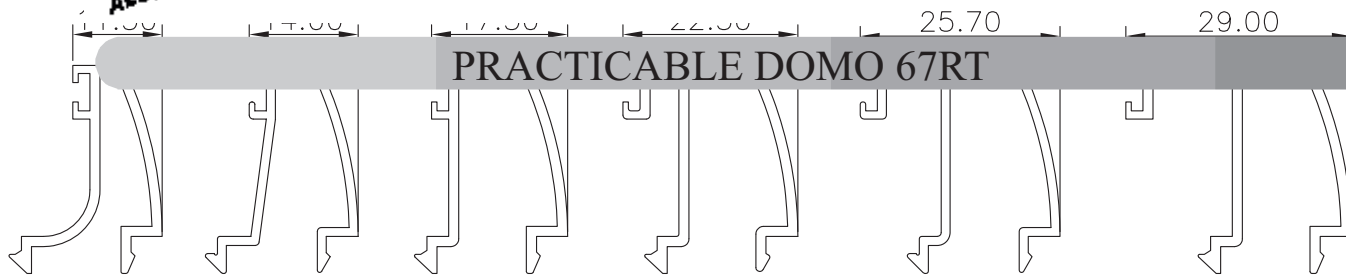

2801

2802

2803

2804

2824

2805

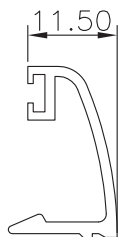

2811

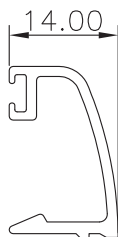

2821

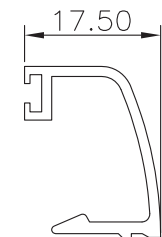

2819

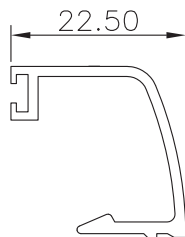

2820

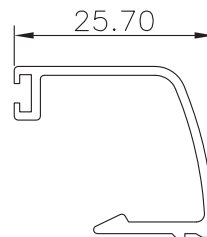

2825

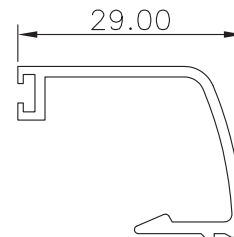

2822

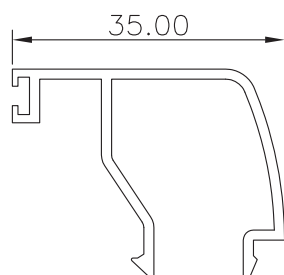

2813

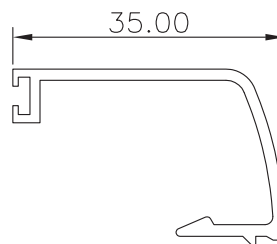

2823

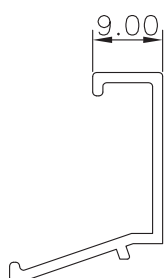

2826

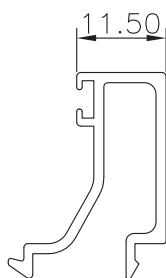

2806

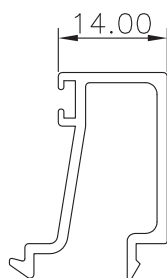

2807

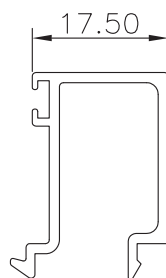

2808

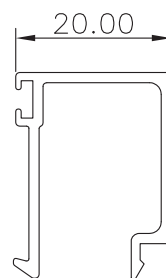

2882

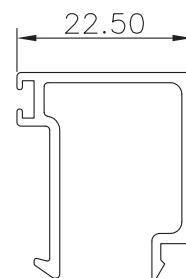

2809

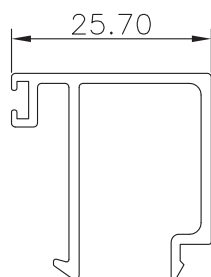

2883

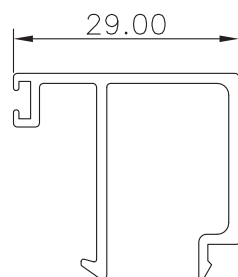

2810

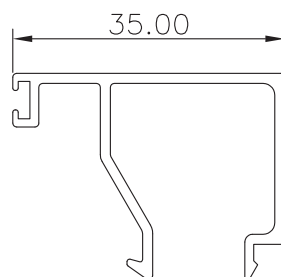

2812

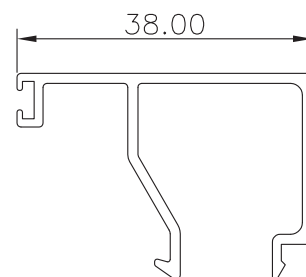

2827

HUECOS LIBRES PARA ACRISTALAR

Junquillo			Hueco (h)
recto	2826	(9.0mm)	52 mm
curvo	2801	(11.5mm)	49 mm
recto	2806	(11.5mm)	49 mm
curvo	2802	(14mm)	47 mm
recto	2807	(14mm)	47 mm
curvo	2803	(17.5mm)	43 mm
recto	2808	(17.5mm)	43 mm
recto	2882	(20.0mm)	41 mm
curvo	2804	(22.5mm)	38 mm
recto	2809	(22.5mm)	38 mm
recto	2883	(25.7mm)	35 mm
curvo	2824	(25.7mm)	35 mm
curvo	2805	(29mm)	32 mm
recto	2810	(29mm)	32 mm
curvo	2813	(35mm)	26 mm
recto	2812	(35mm)	26 mm
recto	2827	(38mm)	23 mm

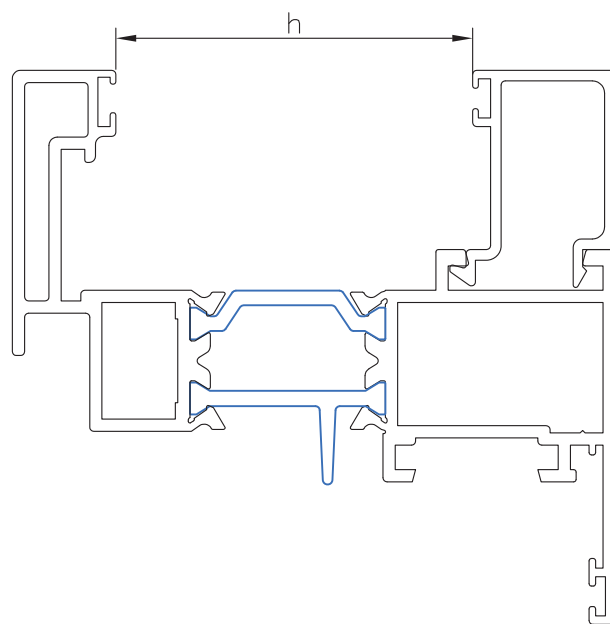

Junquillos grapa para junquillos curvos

Junquillos curvos









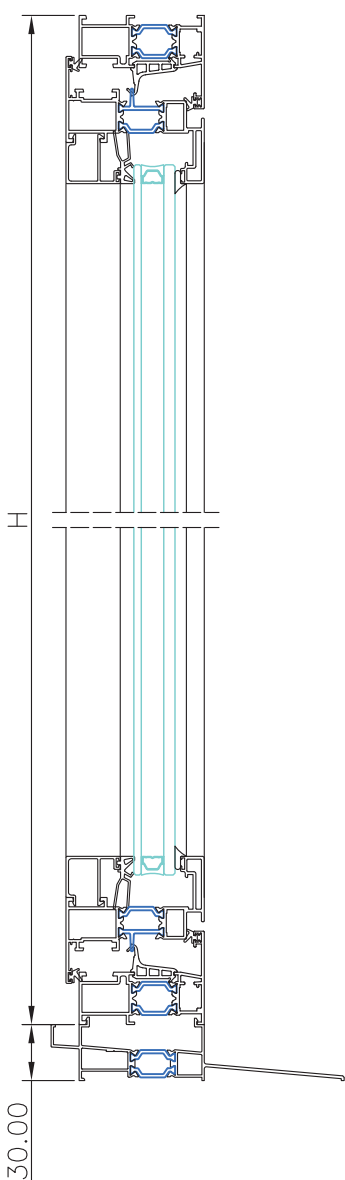
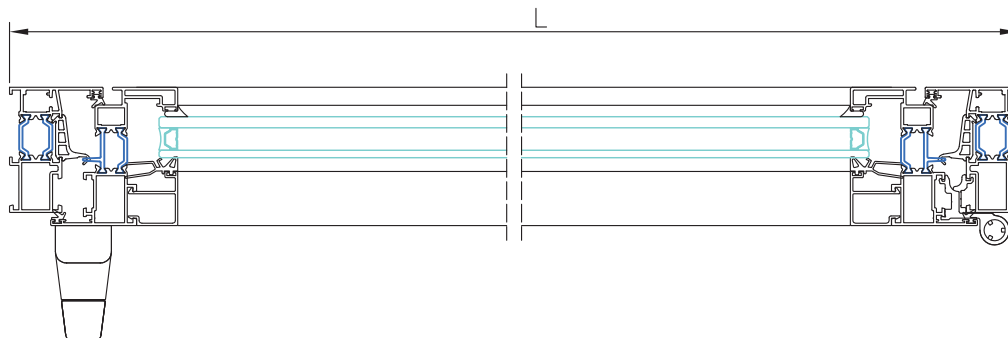





2801	2802	2803	2804	2824	2805	2813
2811	2821	2819	2820	2825	2822	2823

Junquillos grapa

PRACTICABLE DOMO 67RT

Ventana 1 hoja apertura interior - marco 3621 y hoja 3603



	Ref.	Descripción	Horizontal			Vertical		
			Corte	Cantidad	Medida	Corte	Cantidad	Medida
	3621	Marco ventana		2	L		2	H
	3603	Hoja ventana		2	L - 44		2	H - 44
	3695	Condensación		1	L			
		Junquillos corte inglete		2	L - 136		2	H - 136
		Junquillos corte recto		2	L - 136		2	H - 180
	2814	Pletina cremona					1	H / 2

Ref.	Descripción	Horizontal		Vertical	
		Cantidad	Medida	Cantidad	Medida
31051	Junta central	2	L	2	H
31041	Junta batiente (int.- ext.)	4	L	4	H
31066	Junta acristalamiento int.	2	L	2	H
31056	Angulo vulcanizado para j. central	4			

Ref.	Descripción	Cantidad
30180	Escuadra interior hoja y marco	8
30628	Escuadra exterior hoja y marco	8
30184	Escuadra alin. ext. hoja y marco	8
30200	Escuadra alineamiento int. hoja	4
30211	Juego tapas condensación	1
30371	Tapa salida de aguas	L/500
	Herraje	Ver tabla



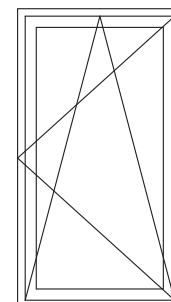





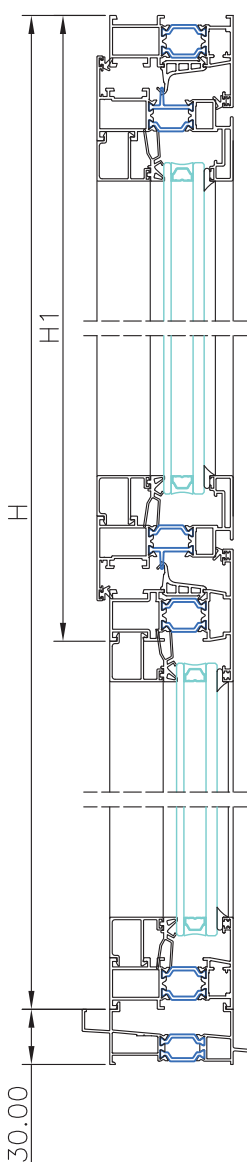
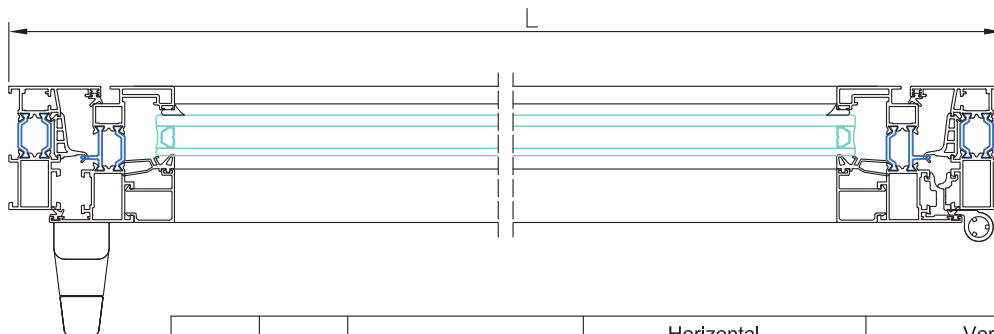







Ctra. Estación, s/n • 36720 GUILLAREI - TUI (Pontevedra)
Teléfono 986 607 133 • Fax 986 607 134



PRACTICABLE DOMO 67RT

Ventana 1 hoja apertura interior con fijo inferior - marco 3621 y hoja 3603



Ref.	Descripción	Horizontal			Vertical		
		Corte	Cantidad	Medida	Corte	Cantidad	Medida
 3621	Marco ventana		2	L		2	H
 3603	Hoja ventana		2	L - 44		2	H1 - 44
 3610	Travesaño ventana		1	L - 46			
 3695	Condensación		1	L			
	Junquillos corte inglete		2	L - 136		2	H1 - 136
			2	L - 56		2	(H-H1) - 28
	Junquillos corte recto		2	L - 136		2	H1 - 180
			2	L - 56		2	(H-H1) - 72

Ref.	Descripción	Horizontal		Vertical	
		Cantidad	Medida	Cantidad	Medida
31051	Junta central	2	L	2	H1
31041	Junta batiente (int.- ext.)	4	L	4	H1
31066	Junta acristalamiento int.	4	L	2	H
31056	Angulo vulcanizado para j. central	4			



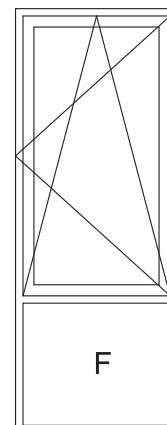





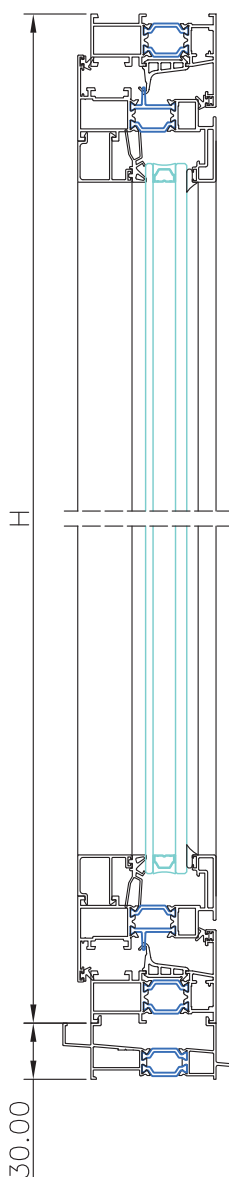
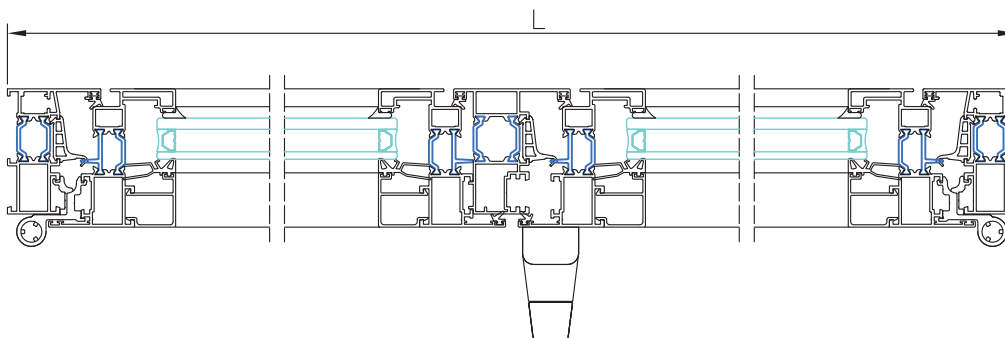







Ref.	Descripción	Cantidad
30180	Escuadra interior hoja y marco	8
30628	Escuadra exterior hoja y marco	8
30184	Escuadra alin. ext. hoja y marco	8
30200	Escuadra alineamiento int. hoja	4
30211	Juego tapas condensación	1
30371	Tapa salida de aguas	L/500
30630	Tope travesaño ventana	2
	Herraje	Ver tabla



PRACTICABLE DOMO 67RT

Ventana 2 hojas apertura interior- marco 3621 y hoja 3603



	Ref.	Descripción	Horizontal			Vertical		
			Corte	Cantidad	Medida	Corte	Cantidad	Medida
	3621	Marco ventana		2	L		2	H
	3603	Hoja ventana		4	L/2 - 25		4	H - 44
	3607	Inversor					1	H - 115
	3695	Condensación		1	L			
		Junquillos corte inglete		4	L/2 - 117		4	H - 136
		Junquillos corte recto		4	L/2 - 117		4	H - 180
	2814	Pletina cremona					1	H / 2

Ref.	Descripción	Horizontal		Vertical	
		Cantidad	Medida	Cantidad	Medida
31051	Junta central	2	L	3	H
31041	Junta batiente (int.- ext.)	4	L	8	H
31066	Junta acristalamiento int.	2	L	4	H
31056	Angulo vulcanizado para j. central	4			



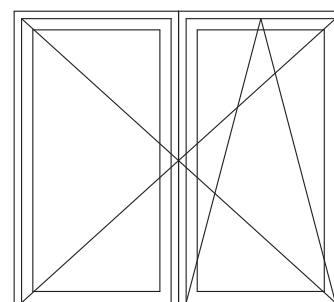





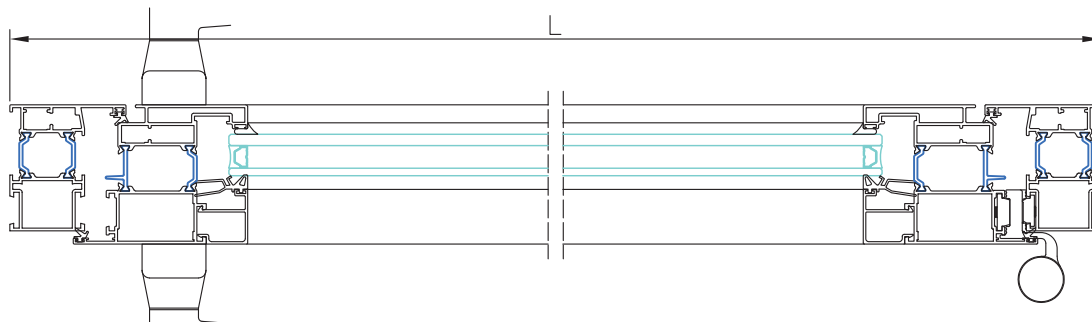



Ref.	Descripción	Cantidad
30180	Escuadra interior hoja y marco	12
30628	Escuadra exterior hoja y marco	12
30184	Escuadra alin. ext. hoja y marco	12
30200	Escuadra alineamiento int. hoja	8
30457	Juego tapas inversor	1
30211	Juego tapas condensación	1
30371	Tapa salida de aguas	L/500
	Herraje	Ver tabla



PRACTICABLE DOMO 67RT

Puerta 1 hoja apertura interior



Ref.	Descripción	Horizontal			Vertical		
		Corte	Cantidad	Medida	Corte	Cantidad	Medida
	3604 Marco puerta		1	L		2	H + 50
	3606 Hoja puerta		2	L - 67		2	H - 39
	3612 Zócalo		1	L - 199			
	Junquillos corte inglete		2	L - 209		2	H - 207
	Junquillos corte recto		3	L - 209		2	H - 251

Ref.	Descripción	Horizontal		Vertical	
		Cantidad	Medida	Cantidad	Medida
31041	Junta batiente (int.- ext.)	2	L	4	H
31066	Junta acristalamiento int.	2	L	2	H



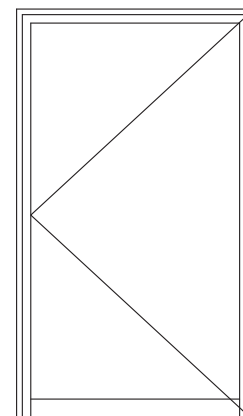
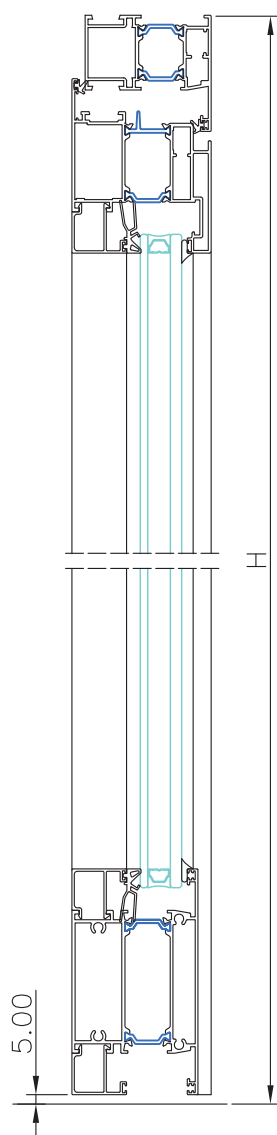





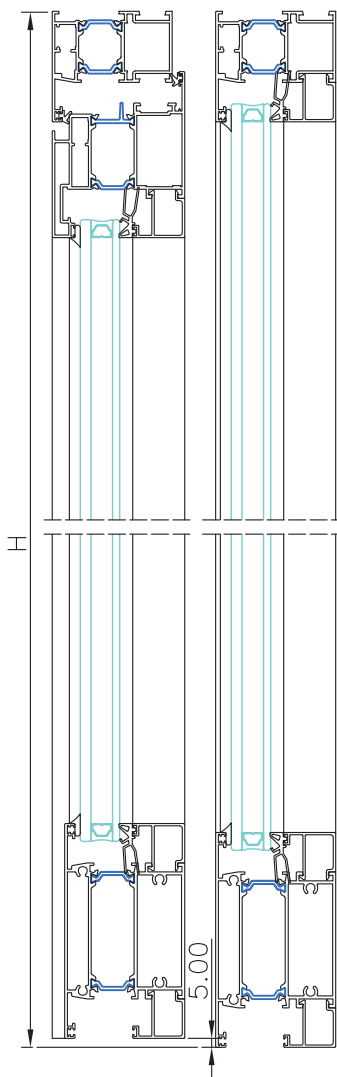
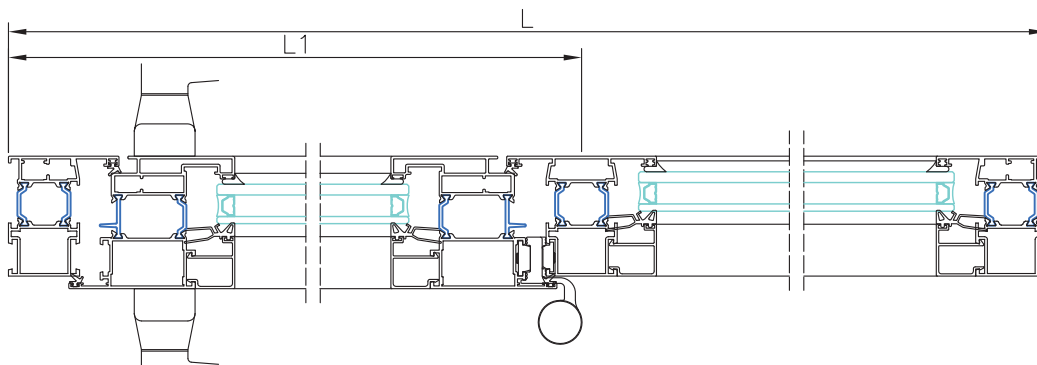





Ref.	Descripción	Cantidad
30170	Escuadra marco puerta	2
30181	Escuadra hoja puerta	2
30628	Escuadra exterior hoja y marco	4
30184	Escuadra alin. ext. hoja y marco	4
30200	Escuadra alineamiento hoja	2
	Manilla	Tabla
	Bisagra	Tabla



PRACTICABLE DOMO 67RT

Puerta 1 hoja apertura interior con fijo lateral



	Ref.	Descripción	Horizontal			Vertical		
			Corte	Cantidad	Medida	Corte	Cantidad	Medida
	3604	Marco puerta		1	L		2	H + 50
	3606	Hoja puerta		2	L1 - 48		2	H - 39
	3612	Zócalo		1 1	L1 - 179 (L-L1) - 50			
	3611	Travesaño puerta					1	H - 35
		Junquillos corte inglete		2 2	L1 - 189 (L-L1) - 60		2 2	H - 207 H - 138
		Junquillos corte recto		2 2	L1 - 189 (L-L1) - 60		2 2	H - 251 H - 182

Ref.	Descripción	Horizontal		Vertical	
		Cantidad	Medida	Cantidad	Medida
31041	Junta batiente (int.- ext.)	2	L1	4	H
31066	Junta acristalamiento int.	2	L	4	H



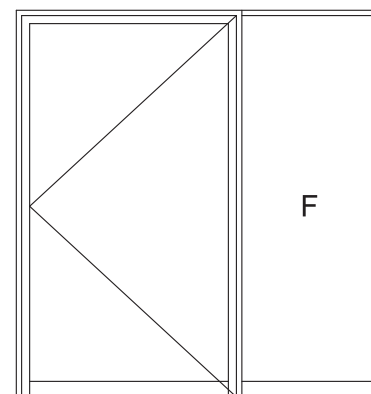





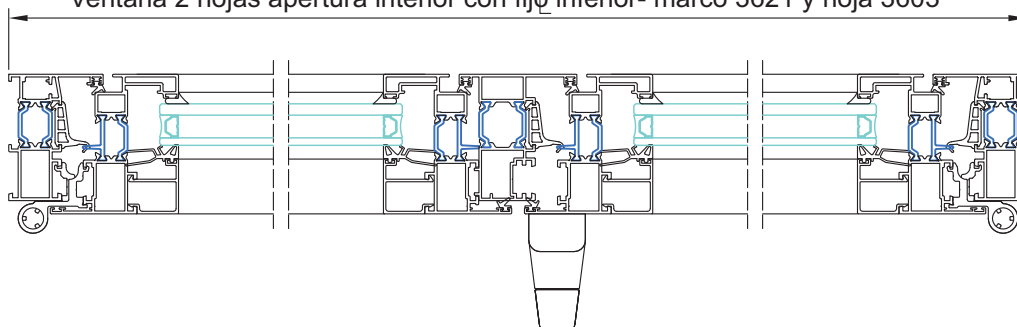













Ref.	Descripción	Cantidad
30170	Escuadra marco puerta	2
30181	Escuadra hoja puerta	2
30628	Escuadra exterior hoja y marco	4
30184	Escuadra alin. ext. hoja y marco	4
30200	Escuadra alineamiento hoja	2
30635	Tope travesaño	2
	Manilla	Tabla
	Bisagra	Tabla



PRACTICABLE DOMO 67RT

Ventana 2 hojas apertura interior con fijo inferior- marco 3621 y hoja 3603



	Ref.	Descripción	Horizontal			Vertical		
			Corte	Cantidad	Medida	Corte	Cantidad	Medida
	3621	Marco ventana		2	L		2	H
	3603	Hoja ventana		4	L/2 - 25		4	H1 - 44
	3607	Inversor					1	H1 - 115
	3610	Travesaño ventana		1	L - 46			
	3695	Condensación		1	L			
		Junquillos corte inglete	 	4 2	L/2 - 117 L - 56	 	4 2	H1- 136 (H-H1) - 28
		Junquillos corte recto	 	4 2	L/2 - 117 L - 56	 	4 2	H1- 180 (H-H1) - 72
	2814	Pletina cremona					1	H1 / 2

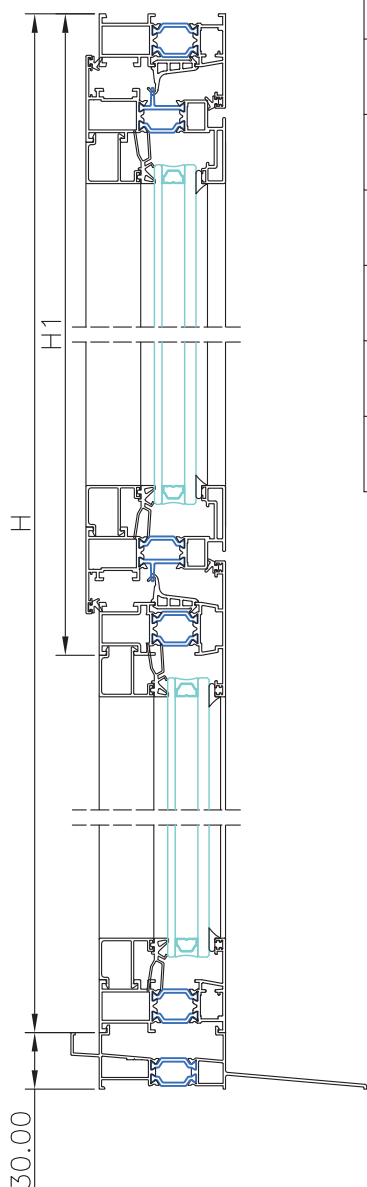

Ref.	Descripción	Horizontal		Vertical	
		Cantidad	Medida	Cantidad	Medida
31051	Junta central	2	L	3	H1
31041	Junta batiente (int.- ext.)	4	L	8	H1
31066	Junta acristalamiento int.	2	L	4	H
31056	Angulo vulcanizado para j. central	4			



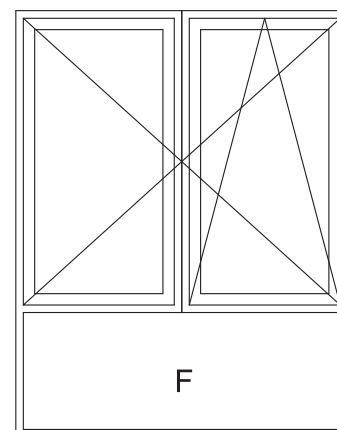





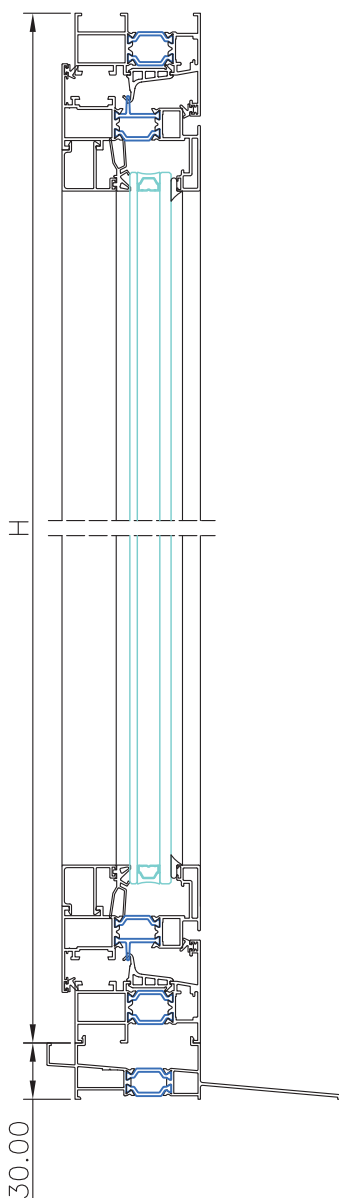
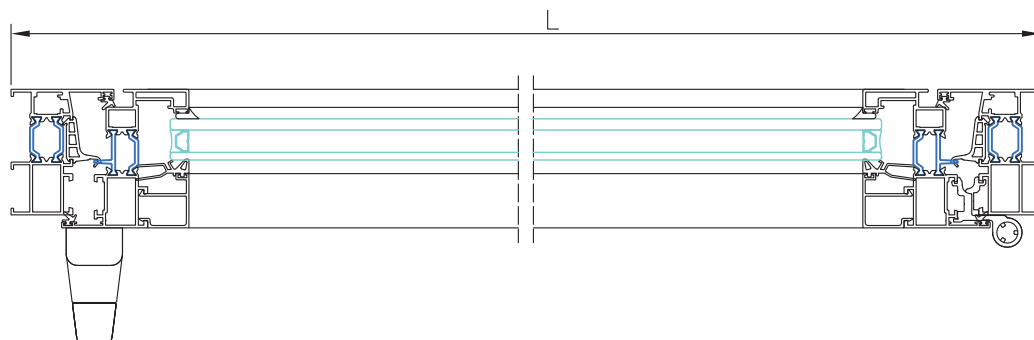





Ref.	Descripción	Cantidad
30180	Escuadra interior hoja y marco	12
30628	Escuadra exterior hoja y marco	12
30184	Escuadra alin. ext. hoja y marco	12
30200	Escuadra alineamiento int. hoja	8
30457	Juego tapas inversor	1
	Kit oscilo-batiente 2 hojas	Ver tabla
30211	Juego tapas condensación	1
30371	Tapa salida de aguas	L/500
30630	Tope travesaño ventana	2



PRACTICABLE DOMO 67RT

Ventana 1 hoja apertura interior- marco 3601 y hoja 3603



	Ref.	Descripción	Horizontal			Vertical		
			Corte	Cantidad	Medida	Corte	Cantidad	Medida
	3601	Marco ventana patilla larga		2	L		2	H
	3603	Hoja ventana		2	L - 54		2	H - 54
	3695	Condensación		1	L			
		Junquillos corte inglete		2	L - 146		2	H - 146
		Junquillos corte recto		2	L - 146		2	H - 190
	2814	Pletina cremona					1	H / 2

Ref.	Descripción	Horizontal		Vertical	
		Cantidad	Medida	Cantidad	Medida
31051	Junta central	2	L	2	H
31041	Junta batiente (int.- ext.)	4	L	4	H
31066	Junta acristalamiento int.	2	L	2	H
31056	Angulo vulcanizado para j. central	4			



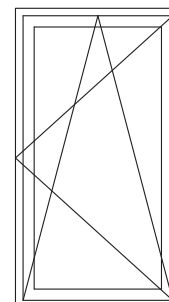





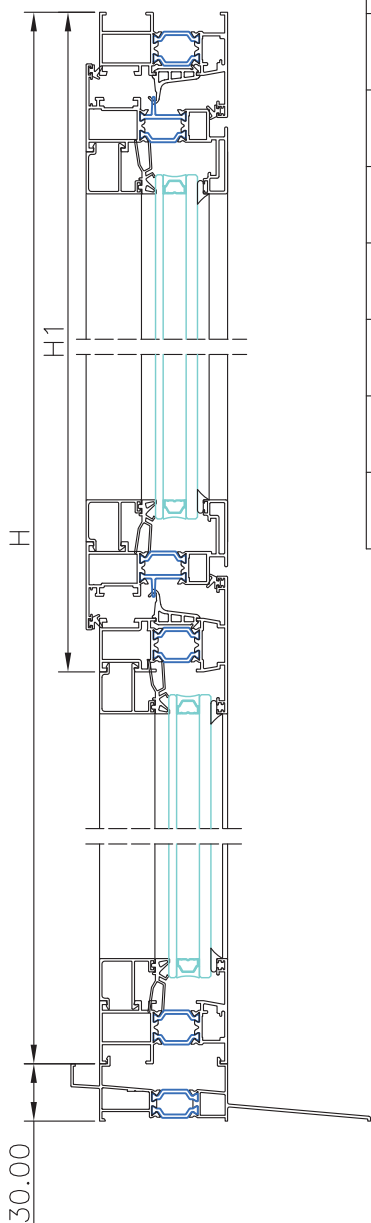
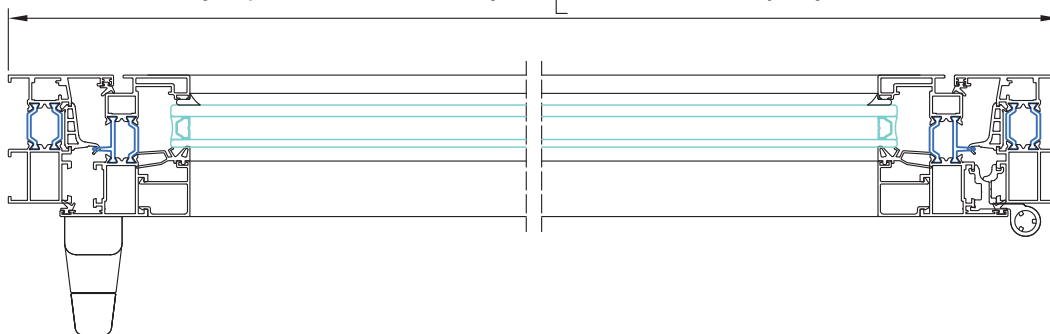





Ref.	Descripción	Cantidad
30180	Escuadra interior hoja y marco	8
30628	Escuadra exterior hoja y marco	8
30184	Escuadra alin. ext. hoja y marco	8
30200	Escuadra alineamiento int. hoja	4
30211	Juego tapas condensación	1
30371	Tapa salida de aguas	L/500
	Herraje	Ver tabla



PRACTICABLE DOMO 67RT

Ventana 1 hoja apertura interior con fijo inferior- marco 3601 y hoja 3603



Ref.	Descripción	Horizontal			Vertical		
		Corte	Cantidad	Medida	Corte	Cantidad	Medida
3601	Marco ventana patilla larga		2	L		2	H
3603	Hoja ventana		2	L - 54		2	H1 - 49
3610	Travesaño ventana		1	L - 56			
3695	Condensación		1	L			
	Junquillos corte inglete		2	L - 146		2	H1 - 141
			2	L - 66		2	(H-H1) - 33
	Junquillos corte recto		2	L - 146		2	H1 - 185
			2	L - 66		2	(H-H1) - 77
2814	Pletina cremona					1	H1 / 2

Ref.	Descripción	Horizontal		Vertical	
		Cantidad	Medida	Cantidad	Medida
31051	Junta central	2	L	2	H1
31041	Junta batiente (int.- ext.)	4	L	4	H1
31066	Junta acristalamiento int.	4	L	2	H
31056	Angulo vulcanizado para j. central	4			

Ref.	Descripción	Cantidad
30180	Escuadra interior hoja y marco	8
30628	Escuadra exterior hoja y marco	8
30184	Escuadra alin. ext. hoja y marco	8
30200	Escuadra alineamiento int. hoja	4
30211	Juego tapas condensación	1
30371	Tapa salida de aguas	L/500
30630	Tope travesaño ventana	2
	Kít oscilo-batiente 1 hoja	Ver tabla

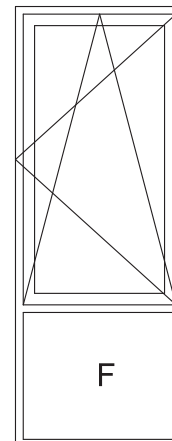

PRACTICABLE DOMO 67RT

Ventana 2 hojas apertura interior- marco 3601 y hoja 3603

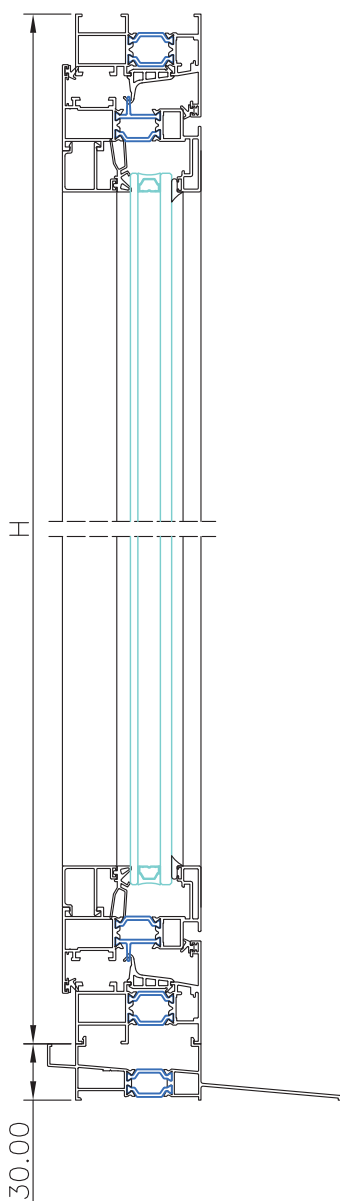
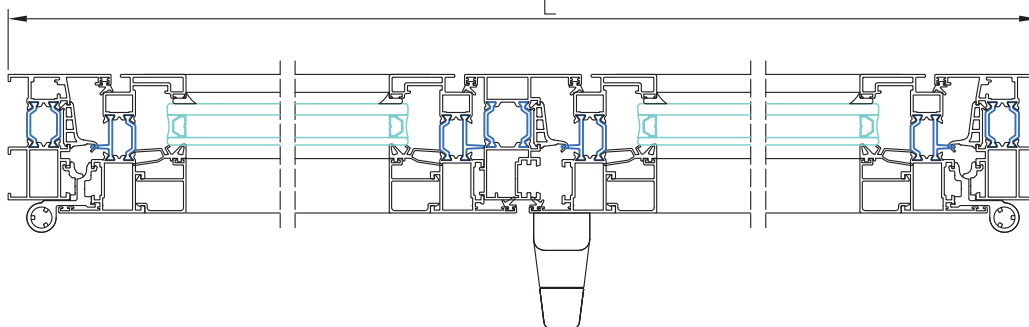

Ref.	Descripción	Horizontal			Vertical		
		Corte	Cantidad	Medida	Corte	Cantidad	Medida
3601	Marco ventana patilla larga		2	L		2	H
3603	Hoja ventana		4	L/2 - 30		4	H - 54
3607	Inversor					1	H - 125
3695	Condensación		1	L			
	Junquillos corte inglete		4	L/2 - 122		4	H - 146
	Junquillos corte recto		4	L/2 - 122		4	H - 190
2814	Pletina cremona					1	H / 2

Ref.	Descripción	Horizontal		Vertical	
		Cantidad	Medida	Cantidad	Medida
31051	Junta central	2	L	3	H
31041	Junta batiente (int.- ext.)	4	L	8	H
31066	Junta acristalamiento int.	2	L	4	H
31056	Angulo vulcanizado para j. central	4			



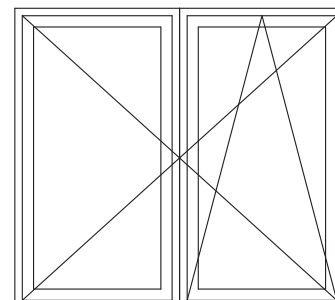





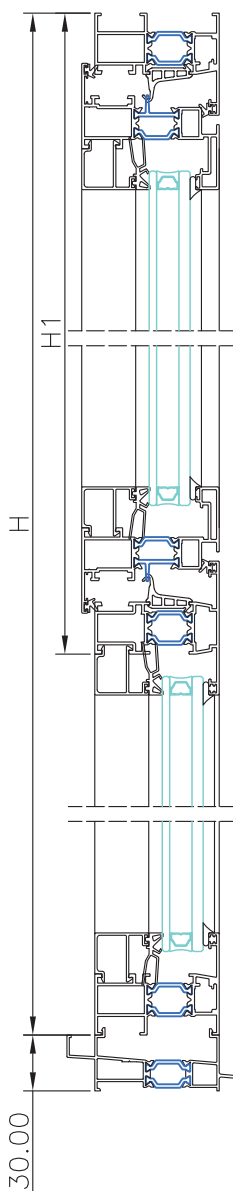
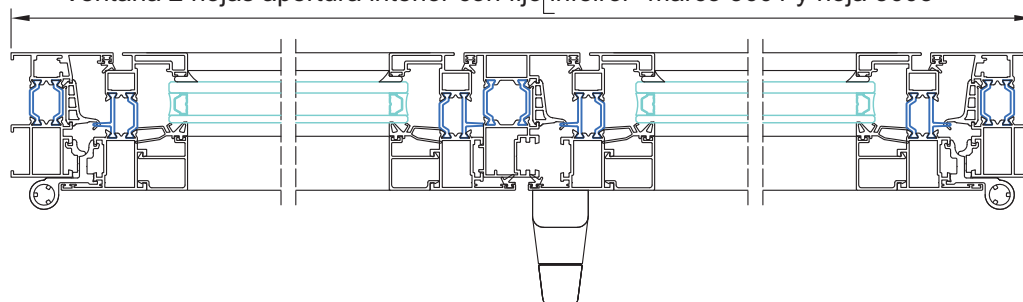







Ref.	Descripción	Cantidad
30180	Escuadra interior hoja y marco	12
30628	Escuadra exterior hoja y marco	12
30184	Escuadra alin. ext. hoja y marco	12
30200	Escuadra alineamiento int. hoja	8
30457	Juego tapas inversor	1
30211	Juego tapas condensación	1
30371	Tapa salida de aguas	L/500
	Kit oscilo-batiente 2 hojas	Ver tabla



PRACTICABLE DOMO 67RT

Ventana 2 hojas apertura interior con fijo inferior- marco 3601 y hoja 3603



Ref.	Descripción	Horizontal			Vertical		
		Corte	Cantidad	Medida	Corte	Cantidad	Medida
3601	Marco ventana patilla larga		2	L		2	H
3603	Hoja ventana		4	L/2 - 30		4	H1 - 49
3607	Inversor					1	H1 - 120
3610	Travesaño ventana		1	L - 56			
3695	Condensación		1	L			
	Junquillos corte inglete		4	L/2 - 122		4	H1 - 141
			2	L - 66		2	(H-H1) - 33
	Junquillos corte recto		4	L/2 - 122		4	H1 - 185
			2	L - 66		2	(H-H1) - 77
2814	Pletina cremona					1	H1 / 2

Ref.	Descripción	Horizontal		Vertical	
		Cantidad	Medida	Cantidad	Medida
31051	Junta central	2	L	3	H
31041	Junta batiente (int.- ext.)	4	L	8	H
31066	Junta acristalamiento int.	2	L	4	H
31056	Angulo vulcanizado para j. central	4			



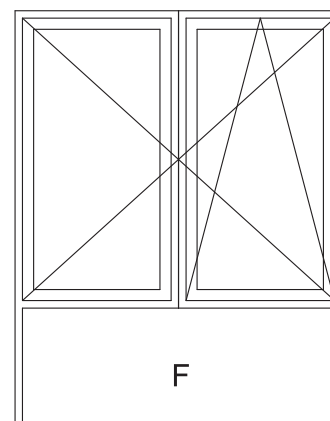





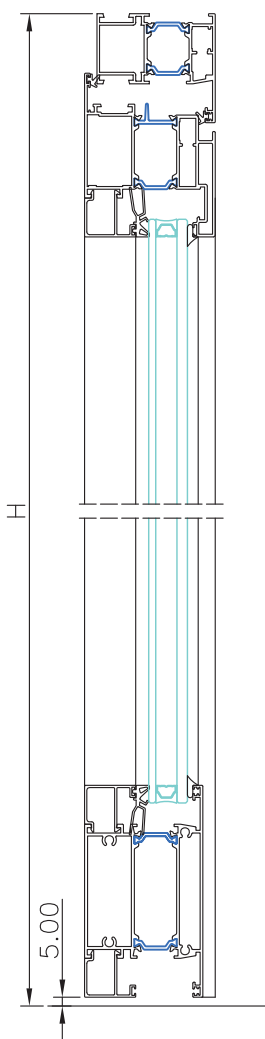
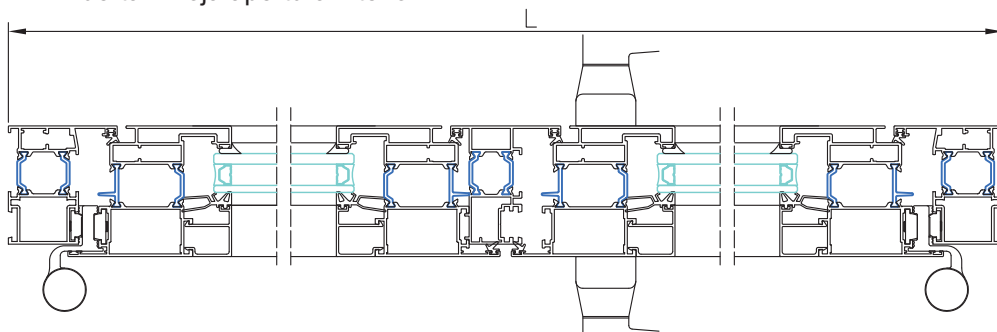





Ref.	Descripción	Cantidad
30180	Escuadra interior hoja y marco	12
30628	Escuadra exterior hoja y marco	12
30184	Escuadra alin. ext. hoja y marco	12
30200	Escuadra alineamiento int. hoja	8
30457	Juego tapas inversor	1
30211	Juego tapas condensación	1
30371	Tapa salida de aguas	L/500
30630	Tope travesaño ventana	2
	Kit oscilo-batiente 2 hojas	Ver tabla



PRACTICABLE DOMO 67RT

Puerta 2 hoja apertura interior



	Ref.	Descripción	Horizontal			Vertical		
			Corte	Cantidad	Medida	Corte	Cantidad	Medida
	3604	Marco puerta		2	L		2	H + 50
	3606	Hoja puerta		4	L/2 - 37		4	H - 39
	3607	Inversor					1	H - 75
	3612	Zócalo		2	L/2 - 168			
		Junquillos corte inglete		4	L/2 - 178		4	H - 207
		Junquillos corte recto		4	L/2 - 178		4	H - 251

Ref.	Descripción	Horizontal		Vertical	
		Cantidad	Medida	Cantidad	Medida
31041	Junta batiente (int.- ext.)	2	L	8	H
31066	Junta acristalamiento int.	2	L	4	H



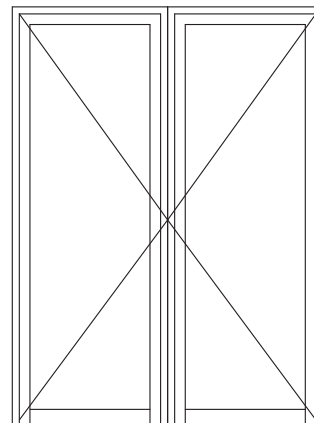





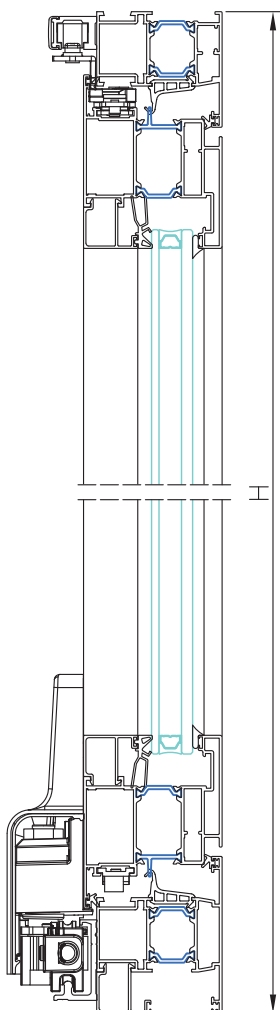
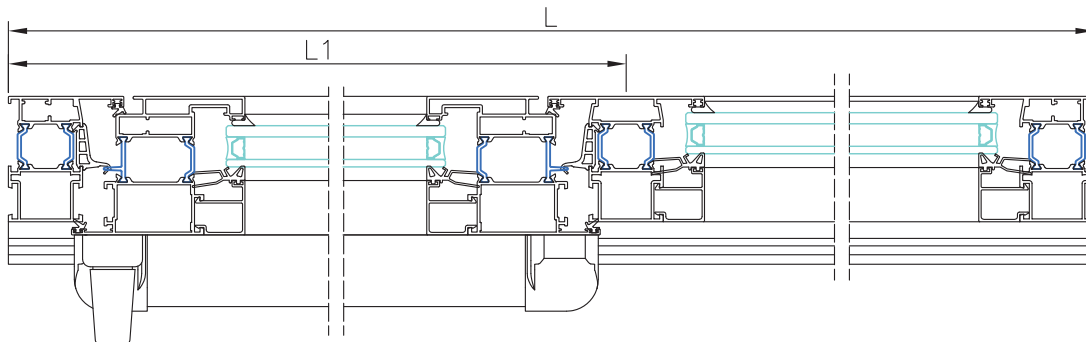









Ref.	Descripción	Cantidad
30170	Escuadra marco puerta	2
30181	Escuadra hoja puerta	4
30628	Escuadra exterior hoja y marco	6
30184	Escuadra alin. ext. hoja y marco	6
30200	Escuadra alineamiento hoja	4
30457	Juego tapas inversor	1
	Manilla	Tabla
	Bisagra	Tabla



PRACTICABLE DOMO 67RT

Puerta Oscilo-Paralela



	Ref.	Descripción	Horizontal			Vertical		
			Corte	Cantidad	Medida	Corte	Cantidad	Medida
	3604	Marco puerta		1	L		2	H
	3606	Hoja recta puerta		2	L1 - 48		2	H - 90
	3611	Travesaño puerta		1	L - 70		1	H - 92
		Junquillos corte inglete		2	L1 - 189		2	H - 231
				2	(L-L1) - 60		2	H - 102
		Junquillos corte recto		2	L1 - 189		2	H - 275
				2	(L-L1) - 60		2	H - 146
				1	L - 70			

Ref.	Descripción	Horizontal		Vertical	
		Cantidad	Medida	Cantidad	Medida
31051	Junta central	2	L1	2	H
31041	Junta batiente (int.- ext.)	4	L1	4	H
31066	Junta acristalamiento int.	2	L	4	H
31056	Angulo vulcanizado para j. central	4			



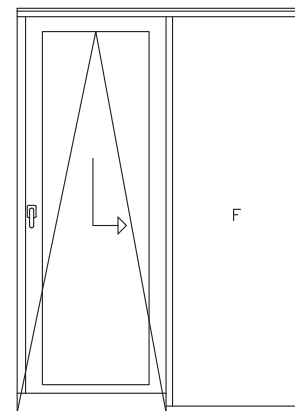





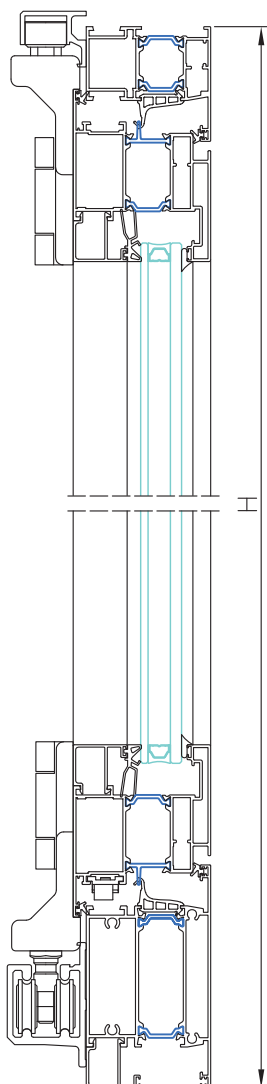
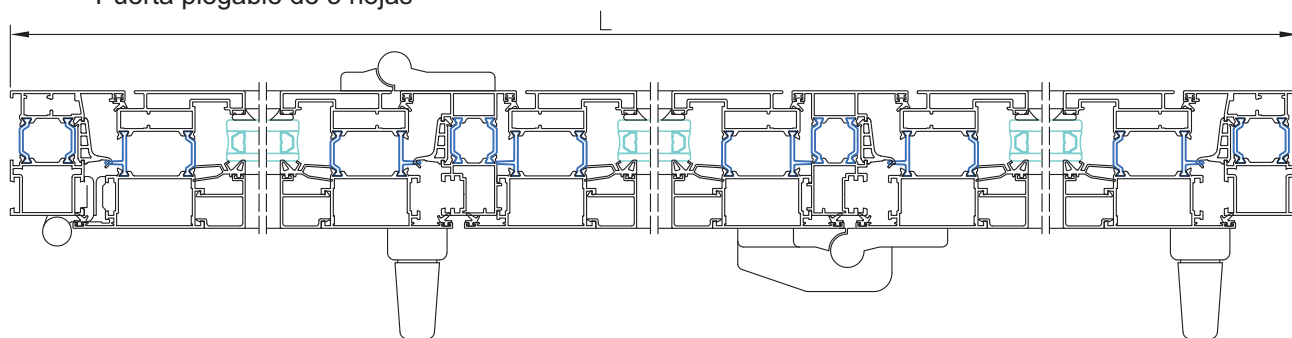





Ref.	Descripción	Cantidad
30170	Escuadra marco puerta	2
30181	Escuadra hoja puerta	4
30628	Escuadra exterior hoja y marco	6
30184	Escuadra alin. ext. hoja	6
30200	Escuadra alineamiento hoja	4
30635	Tope travesaño	4
30371	Tapa salida de aguas	L/500
	Herraje oscilo-paralela	Tabla



PRACTICABLE DOMO 67RT

Puerta plegable de 3 hojas









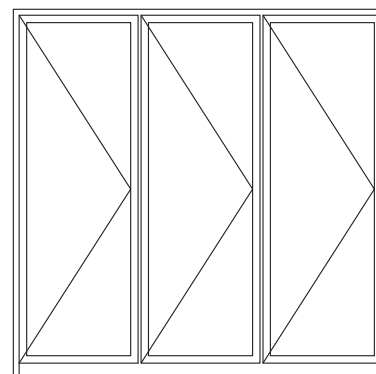

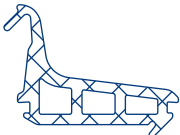
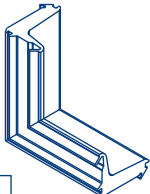
	Ref.	Descripción	Horizontal			Vertical		
			Corte	Cantidad	Medida	Corte	Cantidad	Medida
	3604	Marco puerta		1	L		2	H
	3606	Hoja recta puerta		6	Ver tabla		6	H - 126
	3607	Inversor recto					2	H - 197
	3612	Zócalo		1	L - 70			
		Junquillos corte inglete		6	según hoja		6	H - 258
		Junquillos corte recto		6 1	según hoja según hoja		6	H - 311

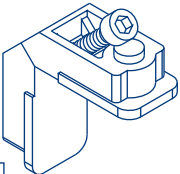
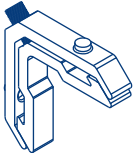
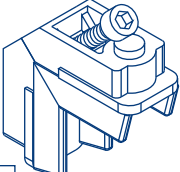
Ref.	Descripción	Horizontal		Vertical	
		Cantidad	Medida	Cantidad	Medida
31051	Junta central	2	L	4	H
31041	Junta batiente (int.- ext.)	2	L	12	H
31066	Junta acristalamiento int.	2	L	6	H
31056	Angulo vulcanizado para j. central	4			

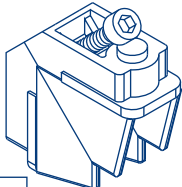
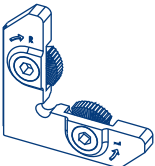
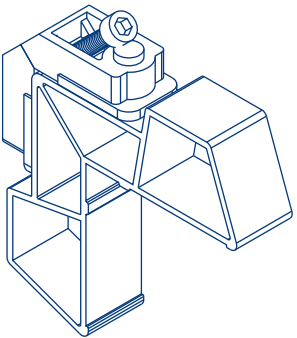
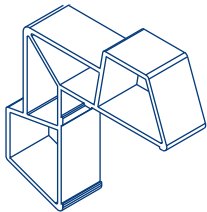
Ref.	Descripción	Pract.
31170	Escuadra marco puerta	2
30181	Escuadra hoja int.	12
30628	Escuadra exterior hoja y marco	14
30184	Escuadra alineamiento ext. hoja	12
30200	Escuadra alineamiento int. hoja	12
30457	Juego tapas inversor	2
30371	Tapa salida de aguas	L/500
	Herraje plegable	Tabla

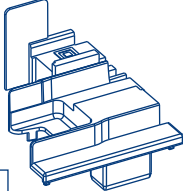

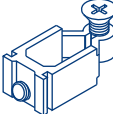
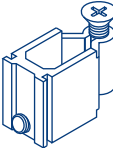
 <p>Ref. 31051 Junta central E.P.D.M.</p> <p>120ml / caja</p>	 <p>Ref. 31056 Ángulo vulcanizado E.P.D.M.</p> <p>400uds / caja</p>
 <p>Ref. 31041 Junta batiente ext. e int. coextrusión</p> <p>300ml / caja</p>	 <p>Ref. 31066 Junta acristalamiento interior</p> <p>75ml / caja</p>
 <p>Ref. 30180 Escuadra de tetón 24x14</p> <p>250uds / caja</p>	 <p>Ref. 30628 Escuadra de vértice 9x14</p> <p>200uds / bolsa</p>
 <p>Ref. 30170 Escuadra de tetón 24x26</p> <p>250uds / caja</p>	 <p>Ref. 30200 Escuadra alineación 30x15x0.8</p> <p>100uds / bolsa 500uds / bolsa</p>
 <p>Ref. 30181 Escuadra de tetón 24x39</p> <p>150uds / caja</p>	 <p>Ref. 30184 Escuadra alineación con excéntricas 50X15x7</p> <p>250uds / caja</p>
 <p>Ref. 30180 Escuadra de tetón 24x14</p> <p>Escuadra 24x39</p>	 <p>Ref. 30187 Suplemento escuadra 25x25</p> <p>70uds / caja</p>

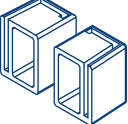
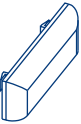
 <p>Ref. 30457 Juego tapa inversora</p> <p>25uds / caja</p>	 <p>Ref. 31065 Junta de arrastre</p> <p>x ml</p>
 <p>Ref. 30630 Tope de zanca ventana 14x18</p> <p>300uds / caja</p>	 <p>Ref. 30635 Tope de zanca puerta 25x18</p> <p>300uds / caja</p>
 <p>Ref. 30645 Grapa de ajunquillar</p> <p>200uds / bolsa</p>	 <p>Ref. 30311 crudo 30312 blanco 30313 negro Esquinero junquillo redondo</p> <p>100uds / bolsa</p>
 <p>Ref. 30211 Juego tapa condensación</p> <p>50jgos / bolsa</p>	 <p>Ref. 30371 negro 30373 blanco Tapa salida de aguas</p> <p>x ud</p>

